

IR Network Intelligent Speed Dome User's Manual

Table of Contents

1	FEATURES AND FUNCTIONS.....	1
1.1	General Introduction	1
1.2	Features.....	1
1.2.1	On-Screen Menu	1
1.2.2	Proportional Pan and Tilt	1
1.2.3	On-screen Tips	1
1.2.4	Preset Setup and Call	1
1.2.5	Auto Scan.....	1
1.2.6	Auto Touring	1
1.2.7	Auto Pattern.....	1
1.2.8	3D Privacy Masking.....	1
1.2.9	Defog.....	2
1.2.10	3D noise reduction.....	2
1.2.11	Action on Alarm.....	2
1.2.12	Auto Flip.....	2
1.2.13	Self-diagnosis.....	2
1.2.14	Day/Night Mode (B/W & Color Mode)	2
1.2.15	Auto Focus	2
1.2.16	Backlight Compensation.....	2
1.2.17	Pan Tilt and Zoom.....	2
1.2.18	FD 3D Intelligent Positioning.....	2
1.2.19	Idle Status.....	2
1.2.20	Image Stabilizer/Flip	2
2	QUICK CONFIGURATION TOOL.....	3
2.1	Overview.....	3
2.2	Operation.....	3
3	WEB OPERATION.....	6
3.1	Network Connection.....	6

3.2	Login and Logout	6
4	MENU	9
4.1	Screen Menu Index	9
4.2	Self-diagnosis System Information	10
4.3	Main Menu	10
4.4	Menu Operation	10
4.4.1	System Information	11
4.4.2	Display Setting	12
4.4.3	Camera Setting	12
4.4.4	Function Setting	18
4.4.5	IR Light Setting	27
4.4.6	Wiper setting	27
4.5	Dome Abnormal Phenomenon Operation	28
4.5.1	Restore to Factory Default Setup	28
4.5.2	PTZ Movement is not smooth	28
5	CABLE CONNECTION	29
5.1	Combination Cable Connection	29
5.2	System Layout	29
5.2.1	System Connection	30
5.2.2	Alarm Connection	30
6	FAQ	31
6.1	Daily Maintenance	31
6.2	Problems and Solutions	31
7	APPENDIX I LIGHTENING PROTECTION AND SURGE PROTECTION	32

8 APPENDIX 2 TOXIC OR HAZARDOUS MATERIALS OR ELEMENTS 33

Welcome

Thank you for purchasing our product!

This user's manual is designed to be a reference tool for the operation of your system.

Here you can find information about this speed dome features and functions, as well as a detailed menu tree.

Please keep it well for future reference!

Before installation and operation, please read the following safeguards and warnings carefully!

Important Safeguards and Warnings

1 . Electrical safety

- All installation and operation here should conform to your local electrical safety codes.
- We assume no liability or responsibility for all the fires or electrical shock caused by improper handling or installation.
- We are not liable for any problems caused by unauthorized modification or attempted repair.

2 . Transportation Security

- No heavy stress, violent vibration or water splash are allowed during transportation, storage and installation.
- Please use the original packing material (or the material of the same quality) when you ship it back to the manufacturer.

3 . Installation

- Do not apply power to the product before completing installation.
- Do not put object on the product.

4 . Environment

- This series product should be installed in a cool, dry place away from direct sunlight, inflammable, explosive substances and etc.
- Please keep it away from the electromagnetic radiation object and environment.
- Please keep the sound ventilation.
- Do not allow the water and other liquid falling into the device. This series product complies with the IP66 standard specified in the Degrees of Protection Provided by Enclosure.
- Please make sure the CCD (CMOS) component is out of the radiation of the laser beam device. Otherwise it may result in CCD (CMOS) optical component damage.
- Usually we recommend thunder-proof device to prevent thunder strike.
- The GND port of the product shall be grounded to further enhance the reliability of the device.

5. Daily Maintenance

- Current series product has no power button. Please unplug all corresponding power cables before your begin installation or daily maintenance work.
- Please keep the dustproof cap back to protect the CCD or CMOS part if the device does not work for a long time.
- Do not touch CCD (CMOS) component. You can use the blower to clean the dust on the surface of the device. You can use the dry cloth with some alcohol or mild detergent to clear if necessary.
- Do not use the volatility solvent such as the benzene or thinner, or detergent with strong abrasibility. It may result in lens damage or it may adversely affect the device performance.
- If there is too much dust, please use the water to dilute the mild detergent first and then use it to clean the device. Finally use the dry cloth to clean the device.

6. About Accessories

Always use all the accessories recommended by manufacturer.

Before installation, please open the package and check that all the components are included in the package:

Contact you local retailer ASAP if something is missing in your package.

1 Features and Functions

1.1 General Introduction

This series IR network intelligent speed dome product is an integrated high intelligent speed dome. It adopts new configuration design and is easy for the project construction. This is a digital and intelligent product of vivid video. The installation is convenient.

Comparing with the previous series product, this series IR network intelligent speed dome has added some new features. It supports 120M IR night vision, intelligent analytics, and the PTZ rotation speed can automatically adjust according to the zoom rate of the lens. It supports various languages, real-time clock function and protocol auto recognition. It supports 360° continuously pan, 100°tilt(-10°-90°) and 180° auto flip. It can realize no blind spot monitor.

1.2 Features

This series speed dome has the following features:

1.2.1 On-Screen Menu

This series product menu supports multiple languages.

It is easy for you to view dome information and configure dome, camera parameters.

1.2.2 Proportional Pan and Tilt

This function keeps the image from moving too fast when there is a large amount of zoom.

The IR high definition speed dome continually decreases or increases pan and tilt speeds in proportion to depth of zoom. When zooms speed is increasing, the camera moving speed becomes slow. When zooms speed is decreasing, the camera moving speed becomes fast.

1.2.3 On-screen Tips

Here you can view:

- Dome title and system version (Software and hardware)
- Dome system temperature. (Optional. You can disable this function)
- Dome pan/tilt coordinates, preset ID.

1.2.4 Preset Setup and Call

Preset function is to save the address information (such as PTZ pan/tilt, focus and etc) to the memory so that you can quickly adjust the dome and PTZ to the correct position.

1.2.5 Auto Scan

Camera scans back and forth regularly in a horizontal field. Here you need to set left and right limit and scan speed.

1.2.6 Auto Touring

Add addresses into a routine in a desired order and then set time and stop duration for each address. The dome will begin an auto touring between these addresses.

1.2.7 Auto Pattern

Memorize dome operation such as pan, tilt, and zoom to repeat. You can call it to repeat the previous operation.

1.2.8 3D Privacy Masking

Privacy masking is a user-defined, four-sided area that can not be viewed by you. The masking area will move with pan and tilt functions and automatically adjust in size as the lens zooms.

1.2.9 Defog

Customized defog setup in case the fog environment may affect the video quality. It is to enhance video resolution.

1.2.10 3D noise reduction

Support 3D noise reduction setup to reduce the camera noise under the low illumination environment. It is to enhance video quality.

1.2.11 Action on Alarm

This series IR high definition speed dome has 7 alarm inputs (normal open or normal close) and 2 alarm outputs (normal open). Alarms can be individually programmed to associated activation action(s) when received. .

1.2.12 Auto Flip

As long as you continue to hold the keyboard joystick in the down position, the dome rotates 180 degrees and repositions itself for uninterrupted viewing of any subjects that passes directly beneath the dome.

1.2.13 Self-diagnosis

There is a self diagnosis procedure when dome boots up.

- Tilt and vertical engine check
- Camera diagnostics (mainly zoom function diagnosis)
- Display dome information.

1.2.14 Day/Night Mode (B/W & Color Mode)

Auto/manual switches in low illumination. There are several modes such as photoresistor, auto, manual and etc. This function needs the speed dome driver (camera) supported.

1.2.15 Auto Focus

Support camera auto focus function.

1.2.16 Backlight Compensation

Balance the brightest and darkest sections of a scene to produce a more vivid picture.

1.2.17 Pan Tilt and Zoom

Supports zoom in and zoom out during tilt and pan movement.

You can still get vivid image even you set auto focus and auto iris during this period.

1.2.18 FD 3D Intelligent Positioning

Support 3D intelligent positioning function. The speed dome can auto track to the specified zone.

1.2.19 Idle Status

When there is no available order for specified duration, you can use menu to set dome idle status.

1.2.20 Image Stabilizer/Flip

You can enable image stabilizer function and flip in the menu.

When there is vibration, this IS function can guarantee video stability and when flip, you can view video more clearly.

This function needs speed dome driver (camera) supported.

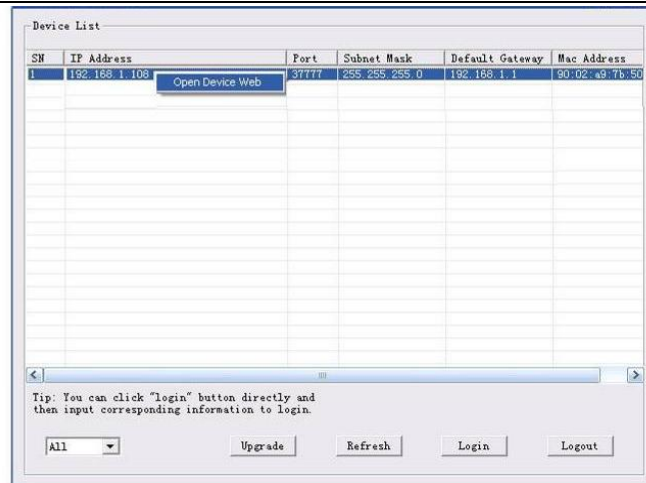

Figure 2-2

Select the “Open Device Web” item; you can go to the corresponding web login interface. See Figure 2-3.



Figure 2-3

If you want to modify the device IP address without logging in the device web interface, you can go to the configuration tool main interface to set.

In the configuration tool search interface (Figure 2-1), please select a device IP address and then double click it to open the login interface. Or you can select an IP address and then click the Login button to go to the login interface. See Figure 2-4.

In Figure 2-4, you can view device IP address, user name, password and port. Please modify the corresponding information to login.

Please note the port information here shall be identical with the port value you set in TCP port in Web Network interface. Otherwise, you can not login the device.

If you are using device background upgrade port 3800 to login, other setups are all invalid.

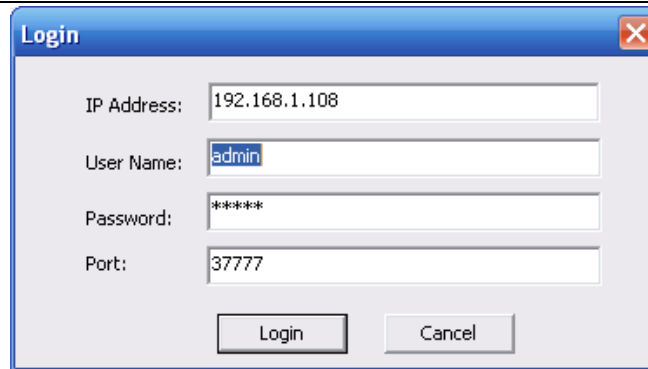

A login dialog box titled "Login" with a close button (X) in the top right corner. It contains four input fields: "IP Address" with the value "192.168.1.108", "User Name" with the value "admin", "Password" with the value "*****", and "Port" with the value "37777". At the bottom, there are two buttons: "Login" and "Cancel".

Figure 2-4

After you logged in, the configuration tool main interface is shown as below. See Figure 2-5.

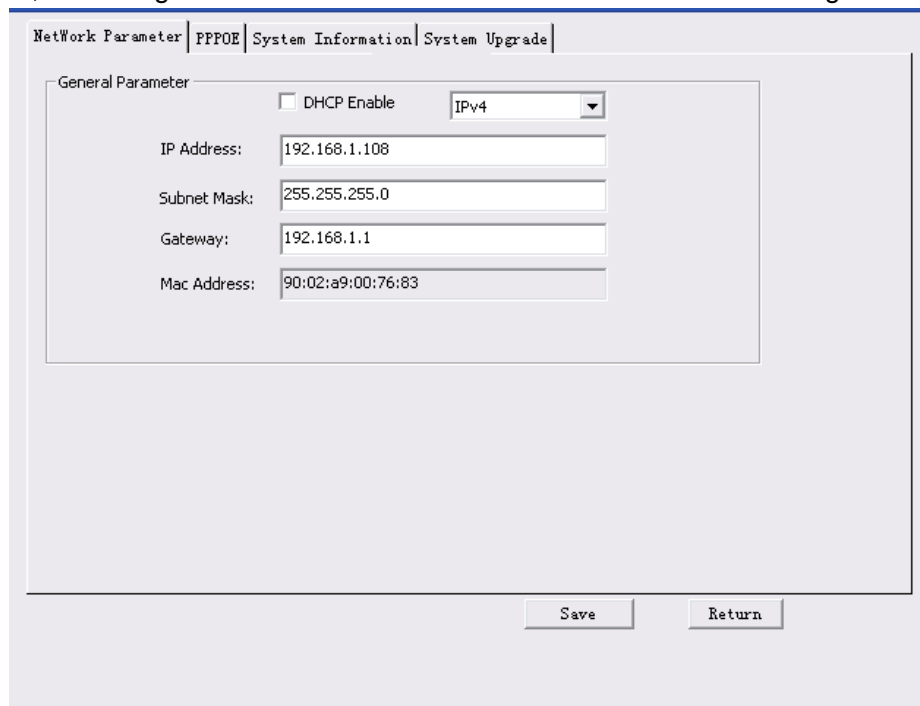

The main interface of the configuration tool, showing a tabbed menu at the top with "Network Parameter", "PPPOE", "System Information", and "System Upgrade". The "Network Parameter" tab is selected. Below the menu is a "General Parameter" section containing a "DHCP Enable" checkbox (unchecked) and a "IPv4" dropdown menu. Below these are four input fields: "IP Address" (192.168.1.108), "Subnet Mask" (255.255.255.0), "Gateway" (192.168.1.1), and "Mac Address" (90:02:a9:00:76:83). At the bottom right, there are "Save" and "Return" buttons.

Figure 2-5

For detailed information and operation instruction of the quick configuration tool, please refer to the *Quick Configuration Tool User's Manual* included in the resources CD.

3 Web Operation

This series speed dome product supports the Web access and management via PC. Web includes several modules: live view, playback, PTZ, setup, alarm, logout and etc.

Speed dome factory default setup:

- IP address: 192.168.1.108.
- User name: admin
- Password: admin

3.1 Network Connection

Please follow the steps listed below for network connection.

- Make sure the speed dome has connected to the network properly.
- Speed dome IP address and PC IP address shall be in the same network segment. Speed dome default IP address is 192.168.1.108. If there is router, please set the corresponding gateway and subnet mask.
- Use order ping `***.***.***.***` (* speed dome address) to check connection is OK or not.

3.2 Login and Logout

Open IE and input speed dome address in the address bar.

For example, if your speed dome IP is 192.168.1.108, then please input `http:// 192.168.1.108` in IE address bar. See Figure 3-1.

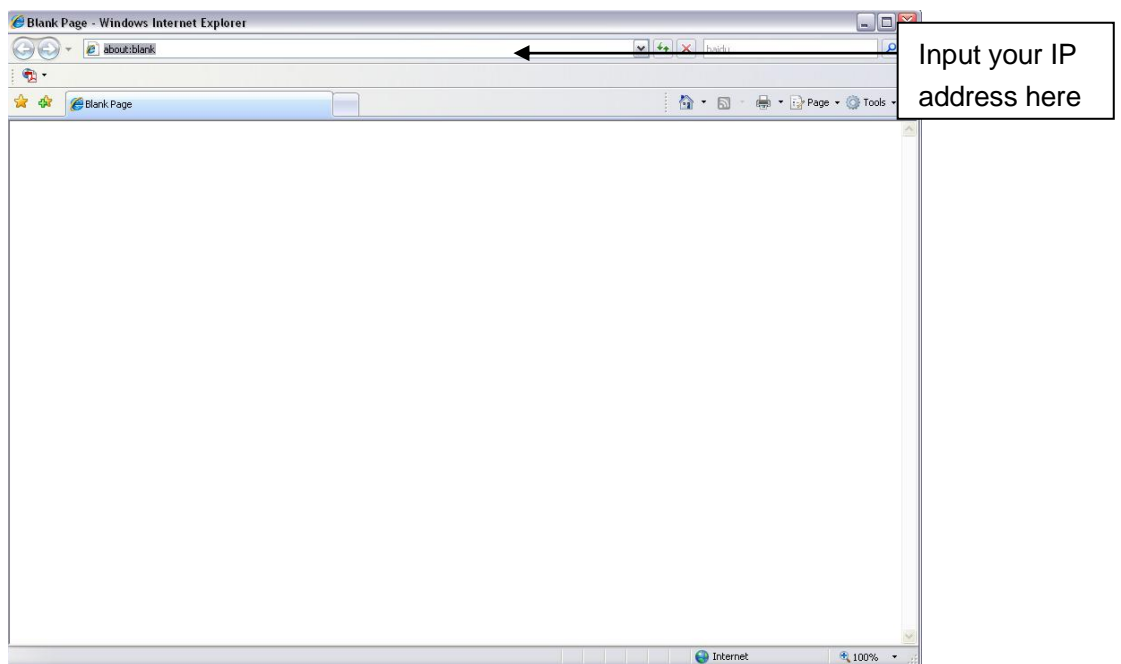

Figure 3-1

System pops up warning information to ask you whether install control webrec.cab or not. Please click OK button, system can automatically install the control. When system is upgrading, it can overwrite the previous Web too.

If you can't download the ActiveX file, please check whether you have installed the plug-in to disable the control download. Or you can lower the IE security level. See Figure 3-2.

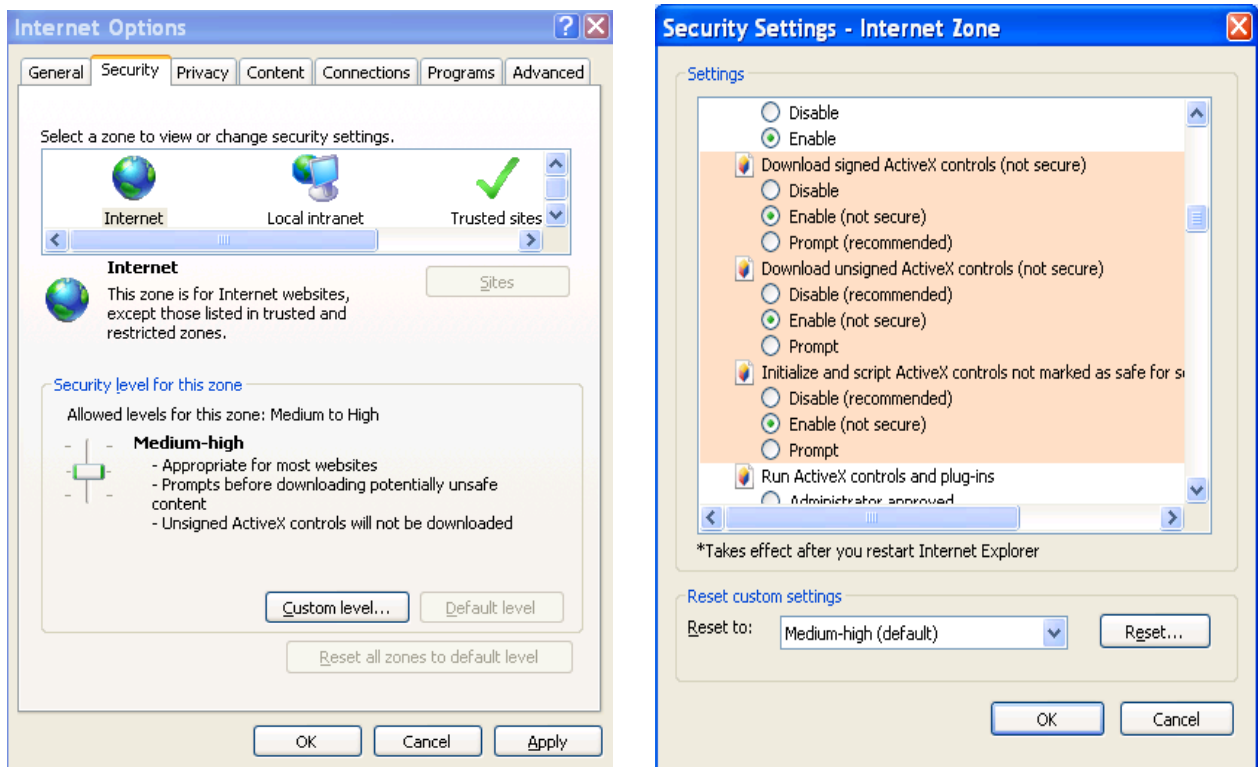

Figure 3-2

After installation, the interface is shown as below. See Figure 3-3.

Please input your user name and password.

Default factory name is **admin** and password is **admin**.

Select the network connection type.

Note: For security reasons, please modify your password after you first login.



Figure 3-3

After you logged in, you can see the main window. See Figure 3-4.

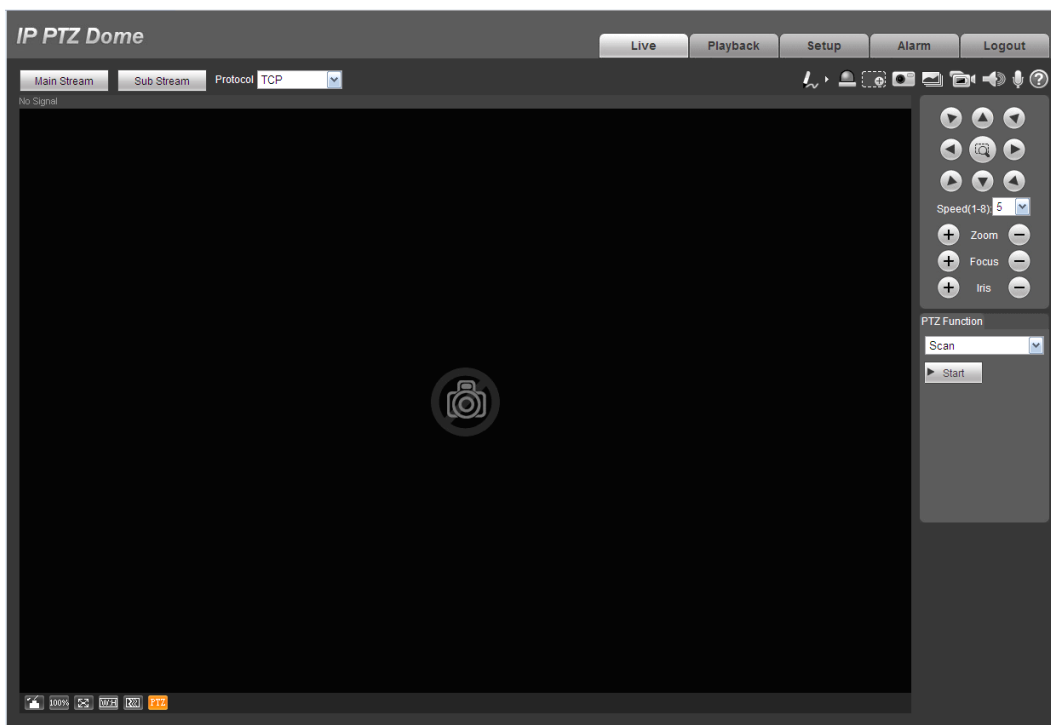

Figure 3-4

Please refer to the *Web Operation Manual* included in the resource CD for detailed operation instruction.

4 Menu

4.1 Screen Menu Index

Note:

ERR means current setup is invalid; you need to restore speed dome factory default setup. Slight difference may be found due to different series.

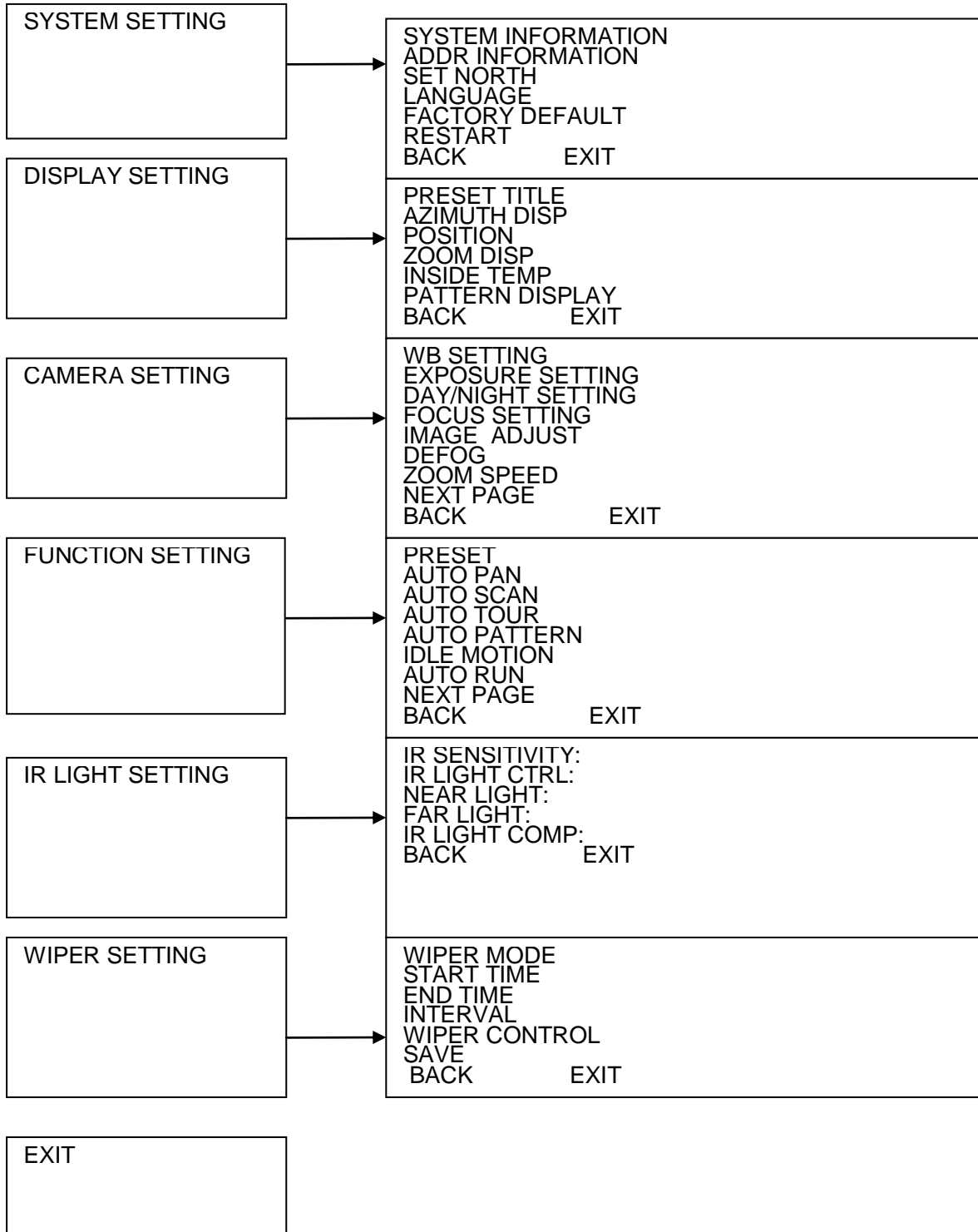

The above diagram illustrates the overall structure of the speed dome setup menu.

Note:

- ERR means current setup is invalid.
- Please make sure all the cable connections are right.

4.2 Self-diagnosis System Information

ADDR	:	001-S
BAUD RATE	:	9600
PARITY	:	NONE
SOFTWARE	:	V1.02.0.R
BACK	:	EXIT

After installation, please connect speed dome to power. The system goes on a self-diagnosis, and then it pops up the above interface to show the system information.

The above interface disappears after speed dome received the first command (or the display time lasts for 20 seconds.)

- ADDR: Here you can view dome address information. For example, 001-S, 1 is the address number, -S is software address mode.
- Baud rate: Dome communication baud rate.
- Parity: Communication parity bit format.
- Software: Dome PTZ software version.

When you are using the control keyboard or the matrix host to control the device, please make sure the control parameter of the keyboard or the matrix host is the same with the speed dome OSD (including address, baud rate, parity). Please make sure the cable connection is OK.

4.3 Main Menu

You can open the IP dome menu via control keyboard, matrix, or speed dome control terminal.

SYSTEM SETTING
DISPLAY SETTING
CAMERA SETTING
FUNCTION SETTING
IR LIGHT SETTING
WIPER SETTING
EXIT

- SYSTEM SETTING: Display speed dome system information, address information. Here you can set north direction, language, factory default setup, reboot and so on.
- DISPLAY SETTING: Display dome preset title, azimuth display, time, direction, dome internal temperature, title information, zoom information and etc.
- CAMERA SETTINGS: Set dome white balance, camera parameter, day/night setup and etc.
- FUNCTION SETTING: Set preset, pan, auto scan, auto tour, pattern, idle function, time task and privacy mask function.
- IR LIGHT SETTING: Set dome IR sensitivity, IR control principle, medium and far light bright, far light bright, IR light compensation and etc.
- WIPER SETTING: It is to set wiper mode, start time, end time, interval, wiper control and etc.
- EXIT: Log out the system menu.

4.4 Menu Operation

In the speed dome main menu, you can use the left/right button on the keyboard or in the speed dome terminal menu to configure the system menu. Before setup, please move the cursor to the current item you want to configure.

- In main menu, please click confirm button to go to the sub menu or use left/right key to configure setup.
- Use up/down button to select back option and then click confirm button to go back to the previous menu.
- Use up/down button to select exit option and then click confirm button to log out system menu.
- All setup here will not lose when encounter power failure.

4.4.1 System Information

```

SYSTEM INFORMATION
ADDR INFORMATION
SET NORTH
LANGUAGE
FACTORY DEFAULT
RESTART
BACK                EXIT
    
```

Move the cursor to SYSTEM SETTING and then click confirm button, you can go to the third submenu. Please use the left/right button on the keyboard or in the speed dome terminal menu to set. After completed setup, please click save button to save current setup.

- **SYSTEM INFORMATION:** Move the cursor to SYSTEM INFORMATION and then click confirm button to go to the third submenu.
- **ADDR INFORMATION:** Move the cursor to SITE INFORMATION and then click confirm button to go to the third submenu.
- **SET NORTH DIRECTION:** Set dome benchmark direction so that you can know the angel between the benchmark and then current location. Please move the cursor to the option and then click confirm button until you see O.K. Now you have set north direction.
- **LANGUAGE:** The dome menu language. There are several languages for you to select. Please use the left/right button on the keyboard or in the speed dome terminal menu to set.
- **FACTORY DEFAULT:** Restore dome factory default setup. Please move the cursor to the option and then click confirm button until you see O.K. Now you can see the IP dome begin rebooting to restore factory default setup.
- **RESTART:** Reboot the speed dome.
- **BACK:** Go back to the previous menu.
- **EXIT:** Log out system menu.

4.4.1.1 System information

```

ADDR       : 001-S
BAUD RATE  : 9600
PARITY     : NONE
SOFTWARE   : V1.02.0.RHNDCC
BACK      : EXIT
    
```

Move the cursor to SYSTEM INFORMATION and then click confirm button, you can see the above interface. Here you can view dome basic information.

4.4.1.2 Address Information

```

ADDR TYPE  : SOFT
ADDR-SOFT  : 001
BACK      : EXIT
    
```

Move the cursor to SITE INFORMATION and then click confirm button.

- ADDR TYPE: System supports software address only.
- ADDR-SOFT: It is to display speed dome software address. Please use the left/right button on the keyboard or in the speed dome terminal menu to set. The value ranges from 1 to 255.
- BACK: Go back to the previous menu.
- EXIT: Log out system menu.

4.4.2 Display Setting

Before the operation, please make sure you purchased camera supports zoom function.

```

PRESET TITLE :
AZIMUTH DISP :
POSITION      :
ZOOM DISP    :
INSIDE TEMP   :
TITLE DISP   :
PATTERN DISP :
BACK         EXIT
    
```

Move the cursor to DISPLAY SETTING and then click confirm button, you can go to the third submenu. Please use the left/right button on the keyboard or in the speed dome terminal menu to set. After completed setup, please click save button to save current setup.

- PRESET TITLE: Display dome preset title or not. Please use the left/right button on the keyboard or in the speed dome terminal menu to set. You can go to Function Setup->Preset section to set corresponding preset value and preset title.
- AZIMUTH DISP: Display dome current coordinates or not. Please use the left/right button on the keyboard or in the speed dome terminal menu to set
- POSITION: Display the angel between the benchmark and then current location. Please use the left/right button on the keyboard or in the speed dome terminal menu to set.
- ZOOM DISP: Display speed dome optical zoom speed or not.
- INSIDE TEMPERATURE: Display dome internal temperature or not. There are three options: °C/F/Off. Please use the left/right button on the keyboard or in the speed dome terminal menu to set.
- PATTERN DISP: It is to set to display speed dome current pattern percentage or not. Please use the left/right button to set.
- BACK: Go back to the previous menu.
- EXIT: Log out system menu.

4.4.3 Camera Setting

Before the operation, please make sure your camera supports the corresponding function.

```

WB SETTING
EXPOSURE SETTING
DAY/NIGHT SETTING
FOCUS SETUP
IMAGE ADJUST
DEFOG
ZOOM SPEED
NEXT PAGE
BACK         EXIT
    
```

```

APERTURE
APERTURE RESTRAIN
DIGITAL ZOOM
PICTURE FLIP
FREEZE FUNCTION
STABLE
CAMERA FACTORY DEFAULTL
CAMERA RESTART
BACK         EXIT
    
```

Move the cursor to CAMERA SETTING and then click confirm button, you can go to the submenu.

- WHITE BALANCE SETUP: Move the cursor to current option and then click confirm button, you can go to the third menu.

- EXPOSURE SETTING: Move the cursor to current option and then click confirm button, you can go to the third menu.
- DAY/NIGHT: Set day/night mode. Move the cursor to current option and then click confirm button, you can go to the third menu. There are three options: auto/manual/off. Please use the left/right button on the keyboard or in the speed dome terminal menu to set. Please make sure your product supports this function.
- FOCUS SETUP: It is to set the camera focus mode, focus limit and etc. Please move the light to highlight current item and then click the OK button to go to the next level menu.
- IMAGE ADJUSTMENT: It is to set the camera hue, saturation, color control, gamma and etc. There is the third menu. Please move the light to highlight current item and then click the OK button to go to the next level menu.
- DEFOG: It is to set camera defog mode and intensity. It can enhance the camera video quality under the fog environment. There is the third menu. Please move the light to highlight current item and then click the OK button to go to the next level menu.
- ZOOM SPEED: The bigger the value, the faster the speed. Please use the left/right button on the keyboard or in the speed dome terminal menu to set.
- NEXT PAGE: It includes the following options: APERTURE, APERTURE RESTRAIN, DIGITAL ZOOM, PICTURE FLIP, FREEZE FUNCTION, STABLE, CAMERA FACTORY DEFAULT SETUP, and CAMERA RESTART. Please use the left/right button on the keyboard or in the speed dome terminal menu to set.
- APERTURE: It is to adjust the lens to achieve clear video. Please use the left/right button on the keyboard or in the speed dome terminal menu to set.
- APERTURE RESTRAIN: System can auto reduce the aperture to lower the video noise when it is in low illumination environment. Please use the left/right button on the keyboard or in the speed dome terminal menu to set.
- DIGITAL ZOOM: You can use the left/right button to enable/disable the digital zoom function.
- PICTURE FLIP: There are two options: on/off. Please use the left/right button on the keyboard or in the speed dome terminal menu to set.
- FREEZE FUNCTION: This function allows the system from one preset to another preset, without showing the video during the PTZ movement. There are two options: on/off. Please use the left/right button on the keyboard or in the speed dome terminal menu to set.
- STABLE : it is to reduce the effect of the vibration on the camera
- CAMERA FACTORY DEFAULT SETTING: Move the cursor to current item and then click confirm button to restore factory default setup.
- CAMERE RESTART: Move the cursor to current item and then click confirm button to reboot the camera.
- BACK: Go back to previous menu.
- EXIT: Log out system menu.

4.4.3.1 White Balance Setup

```

WB MODE : AUTO
R GAIN  : 80
B GAIN  : 80
BACK    EXIT
```

Move the cursor to WHITE BALANCE MODE and then click confirm button, you can go to the submenu.

- WHITE BALANCE MODE: Set white balance adjustment mode. There are several modes such as auto, auto trace white balance, indoor, outdoor, and manual and etc. Please use the left/right button on the keyboard or in the speed dome terminal menu to set.
- R GAIN: Before you set R GAIN option, please note the mode shall not be auto. Please use the left/right button on the keyboard or in the speed dome terminal menu to set.
- B GAIN: Before you set B GAIN option, please note the mode shall not be auto. Please use the left/right button on the keyboard or in the speed dome terminal menu to set.
- BACK: Go back to previous menu.
- EXIT: Log out system menu.

4.4.3.2 Exposure Setting

AE MODE	: AUTO
GAIN SETTING	: 2
SHUTTER	: 1/50
IRIS SETTING	: 11
EXPOSURE COMP	: 8
SLOW AE	: 1
BLC	: OFF
NEXT PAGE	
BACK	EXIT

OW SHUTTER	: ON
SLOW SHUTTER LIMIT	: 1/25
HIGH GAIN	: 3
NOISE REDUCTION	: 2
CAMERA 3D NR	: OFF
GENERAL 3D NR	
HIGH LIGHT REDUCE	: OFF
NEXT PAGE	
BACK	EXIT

AE RECOVERY	: 15M
WDR SETTING	
BACK	EXIT

- AE MODE: Here you can set the camera exposure mode. It includes: auto/manual/AV (iris priority)/TV (shutter priority). Please use the left/right button on the keyboard or in the speed dome terminal menu to set.
 - Auto: The gain, iris and shutter is under auto setup mode
 - Manual: You need to set gain, iris and shutter manually.
 - AV: You can set iris manually. Gain and shutter is under auto setup mode.
 - TV: You can set shutter manually. Gain and iris is under auto setup mode.
- GAIN SETTING: It is to set camera gain. Please use the left/right button on the keyboard or in the speed dome terminal menu to set.
- SHUTTER: It is to set camera shutter speed. Please use the left/right button on the keyboard or in the speed dome terminal menu to set.
- IRIS SETTING: It is to set camera iris value. Please use the left/right button on the keyboard or in the speed dome terminal menu to set.
- EXPOSURE COM: It is to set camera exposure compensation. Please use the left/right button on the keyboard or in the speed dome terminal menu to set.
- SLOW AE: In the strong light environment, you can lower the camera exposure speed to capture the image and enhance the definition. Please use the left/right button on the keyboard or in the speed dome terminal menu to set.
- NEXT PAGE: It includes: SLOW SHUTTER, GAIN MAX LIMIT, SLOW SHUTTER LIMIT, NOISE REDUCTION, 3D NOISE REDUCTION, BLC, WDR, AE resume time, BACK, and EXIT. Move the cursor to the item and then click the left/right button to set.

- SLOW SHUTTER: In lower illumination environment, you can lower the cameras auto exposure time to capture the image and enhance the definition. Please use the left/right button on the keyboard or in the speed dome terminal menu to set.
- SLOW SHUTTER LOW LIMIT: Please click the left/right button to set.
- HIGH GAIN: It is to set high gain threshold. Please click the left/right button to set.
- NOISE REDUCTION: There may noise when the camera is monitoring the low illumination environments. You can use the digital filter to process the noise to guarantee the clear video.
- CAMERA 3D NOISE REDUCTION: It is to set the speed dome 3D noise reduction setup. There is the fourth menu. Please move the light to highlight current item and then click the OK button to go to the next level menu.
- GENERAL 3D NOISE REDUCTION: It is to set the speed dome 3D noise reduction setup. You can set control mode, 3D noise TNF, 3D noise SNF. Please move the light to highlight current item and then click the OK button to go to the next level menu.
- HIGH LIGHT REDUCE: It is to reduce the abruptly strong video on the video in case it affects the video quality. Please click the left/right button to set.
- EXPOSURE RESTRAIN: It is to restrain the abrupt high light on the video in case it affects the video quality. Please click the left/right button to set.
- NEXT PAGE: It includes: AE RECOVERY, WDR SETTING, BACK, and EXIT. Move the cursor to the item and then click the left/right button to set.
 - AE RECOVERY: Manually click the “+” and “-“button on the PTZ interface, system cam resume previous exposure value after specified time (The exposure value does not resume if this function is off.).
 - WDR SETTING: It is an abbreviation for wide dynamic region. Please make sure your camera supports current function. This function can adjust the video brightness when the contrast between the strong light and the dark light is too high. There is the fourth menu. Please move the light to highlight current item and then click the OK button to go to the next level menu.
- BACK: Go back to previous menu.
- EXIT: Log out system menu.

4.4.3.3 3D Noise Reduction

Move the cursor to 3D NOISE REDUCTION and then click confirm button, you can go to the submenu.

CONTROL MODE	: AUTO
3D NOISE MODE	: HIGH
3D NOISE TNF	: OFF
3D NOISE SNF	: OFF
BACK	EXIT

- CONTROL MODE: It is to set 3D noise reduction mode. It includes: off/manual/auto and etc. Please click the left/right button to set.
- 3D NOISE MODE: When the noise reduction mode is auto, you can set intensity. It includes: low/high/default. Please click the left/right button to set.
- 3D NOISE TNF: This function is valid when you set the noise reduction mode as manual. Please use the left/right button on the keyboard or in the speed dome terminal menu to set.

- 3D NOISE SNF: This function is valid when you set the noise reduction mode as manual. Please use the left/right button on the keyboard or in the speed dome terminal menu to set.
- BACK: Go back to previous menu.
- EXIT: Log out system menu.

4.4.3.4 WDR

Move the cursor to WDR and then click confirm button, you can go to the submenu.

WDR MODE	: OFF
BACK	EXIT

- WDR MODE: It is to enable or disable WDR function. Please use the left/right button on the keyboard or in the speed dome terminal menu to set.
- BACK: Go back to previous menu.
- EXIT: Log out system menu.

4.4.3.5 Day/Night Setting

Move the cursor to DAY/NIGHT SETTING and then click confirm button, you can go to the submenu.

DAY/NIGHT	: AUTO
DAY TIME	: 07H 00M
NIGHT TIME	: 19H 00M
THRESHOD	: 4
SAVE	
BACK	EXIT

- DAY/NIGHT: It is to set camera day/night switch mode. It includes: Photosensor/auto/schedule/color/B&W. Please use the left/right button on the keyboard or in the speed dome terminal menu to set.
- DAY TIME: Current setup becomes valid when day/night mode is Time. Move the cursor to DAY TIME item and then click confirm button to go to setup. Please user up/down button to set the value. After completed setup, please click confirm button to exit and move the cursor to Save button to save current setup.
- NIGHT TIME: Current setup becomes valid when day/night mode is Time. Move the cursor to DAY TIME item and then click confirm button to go to setup. Please user up/down button to set the value. After completed setup, please click confirm button to exit and move the cursor to save button to save current setup.
- THRESHOLD: The speed dome can switch the day/night mode when it reached the threshold you set here.
- SAVE: This button is for DAY TIME and NIGHT TIME setup. After you set the day time (or night time), you need to move the cursor here and then click confirm button to save current time setup. For other setups, you do not need to use this button.
- BACK: Go back to previous menu.
- EXIT: Log out system menu.

4.4.3.6 Focus Setup

FOCUS MODE	: AUTO
FOCUS LIMIT	: 10CM
AF SENSITIVITY:	: DEFAULT
IR CORRECTION	: AUTO
BACK	EXIT

- FOCUS MODE: It is to set the camera focus mode. It includes several modes such as auto, manual, semiautomatic.
- FOCUS LIMIT: It is to set the camera focus limit. Please use the left/right button on the keyboard or in the speed dome terminal menu to set.
- AF SENSITIVITY: It is to set the camera focus sensitivity. Please use the left/right button on the keyboard or in the speed dome terminal menu to set.
- IR CORRECTION: It is to set the camera IR light focus correction. Please use the left/right button on the keyboard or in the speed dome terminal menu to set.
- BACK: Go back to previous menu.
- EXIT: Log out system menu.

4.4.3.7 Image Adjust

Move the cursor to IMAGE ADJUST and then click confirm button to go to the submenu to set.

HUE	:	
SATURATION	:	
CHROMA SUPPRESS	:	
GAMMA	:	
BACK	:	EXIT

- HUE: It is to set picture hue. Please use the left/right button on the keyboard or in the speed dome terminal menu to set.
- SATURATION: It is to set picture saturation. Please use the left/right button on the keyboard or in the speed dome terminal menu to set.
- CHROMA SUPPRESS: It is to set picture color control. Please use the left/right button on the keyboard or in the speed dome terminal menu to set.
- GAMMA: It is to set picture gamma. Please use the left/right button on the keyboard or in the speed dome terminal menu to set.
- BACK: Go back to previous menu.
- EXIT: Log out system menu.

4.4.3.8 Defog

Move the cursor to DEFOG and then click confirm button to go to the submenu to set.

DEFOG MODE	:	OFF
INTENSITY	:	1
LIGHT INTENSITY MODE	:	AUTO
LIGHT INTENSITY LEVEL	:	14
BACK	:	EXIT

- DEFOG MODE: It is to set camera defog mode. It includes: manual/auto/off and etc. Please use the left/right button on the keyboard or in the speed dome terminal menu to set.
- INTENSITY: It is valid when the defog mode is manual. Please use the left/right button on the keyboard or in the speed dome terminal menu to set.
- LIGHT INTENSITY MODE: It is to set air light intensity mode. Please use the left/right button on the keyboard or in the speed dome terminal menu to set.
- LIGHT INTENSITY LEVEL: It is to set air light intensity value. It is valid when the air light intensity mode is manual. Please use the left/right button on the keyboard or in the speed dome terminal menu to set.

- BACK: Go back to previous menu.
- EXIT: Log out system menu.

4.4.3.9 Next Page

Move the cursor to NEXT PAGE and then click confirm button, you can go to the submenu.

```

APERTURE           :: 9
APERTURE RESTRAIN  : 5
DIGITAL ZOOM       : OFF
PICTURE FLIP       : OFF
FREEZE FUNC        : OFF
STABLE             : OFF
CAMERA FACTORY DEFAULT
CAMERA RESTATRT
BACK                EXIT
    
```

- APERTURE: It is to adjust the lens to achieve clear video. Please use the left/right button on the keyboard or in the HD-SDI zoom camera terminal menu to set.
- APERTURE RESTRAIN: System can auto reduce the aperture to lower the video noise when it is in low illumination environment. Please use the left/right button on the keyboard or in the HD-SDI zoom camera terminal menu to set.
- DIGITAL ZOOM: You can use the left/right button to enable/disable the digital zoom function.
- PICTURE FLIP: There are two options: on/off. Please use the left/right button on the keyboard or in the speed dome terminal menu to set.
- FREEZE FUNCTION: This function allows the system from one preset to another preset, without showing the video during the PTZ movement. There are two options: on/off. Please use the left/right button on the keyboard or in the speed dome terminal menu to set.
- STABLE : it is to reduce the effect of the vibration on the camera
- CAMERA FACTORY DEFAULT SETTING: Move the cursor to current item and then click confirm button to restore factory default setup.
- CAMERE RESTART: Move the cursor to current item and then click confirm button to reboot the camera.
- BACK: Go back to previous menu.
- EXIT: Log out system menu.

4.4.4 Function Setting

```

PRESET
AUTO PAN
AUTO SCAN
AUTO TOUR
AUTO PATTERN
IDLE FUNCTION
TIME TASK
NEXT PAGE
BACK                EXIT
    
```

```

PRIVACY MASK
PTZ SPEED           : 3
SET ZERO
POWER UP
MENU PASSWORD
MENU IDLE           : OFF
PTZ AUTO STOP       : 15S
NEXT PAGE
BACK                EXIT
    
```

```

HEATER CONTROL
PTZ CORRECTION     : OFF
BACK                EXIT
    
```

Please go back to main menu and move the cursor to FUNCTION SETTING, click confirm button. You can see the above interface.

- PRESET: Move the cursor to PRESET and then click confirm button to go to the third submenu.
- AUTO PAN: Move the cursor to PAN and then click confirm button to go to the third submenu.
- AUTO SCAN: Move the cursor to SCAN and then click confirm button to go to the third submenu.
- AUTO TOUR: Move the cursor to TOUR and then click confirm button to go to the third submenu.
- AUTO PATTERN: Move the cursor to PATTERN and then click confirm button to go to the third submenu.
- IDLE FUNCTION: Move the cursor to IDLE FUNCITON and then click confirm button to go to the third submenu.
- TIME TASK: Move the cursor to TIME TASK and then click confirm button to go to the third submenu.
- NEXT PAGE: It includes: PRIVACY MASKING, PTZ SPEED, SET ZERO, POWER UP, MENU PASSWORD, MENU IDEL, PTZ AUTO STOP, HEATER CONTROL and PTZ CORRECTION. Move the cursor to the item and then click the confirm button to set. .
 - PRIVACY MASK: Here you can set the privacy mask number and etc. It includes the third menu. Please move the cursor to the current item and then click the confirm button to go to the next interface.
 - PTZ SPEED: It is to set PTZ speed. Please use the left/right button to set.
 - SET ZERO: It is to set the PTZ initial position. Please move the PTZ to the corresponding position and then click the confirm button to complete the setup.
 - POWER UP: It is to set the PTZ action when the speed dome boots up. Click the confirm button to go to the next interface. To set
 - MENU PASSWORD: It is to set the password to go to the PTZ menu. Click the confirm button to go to the next interface. To set
 - MENU IDLE: If current setup is ON, once you open the menu and leave it idle for specified period, the menu may automatically disappear. If current setup is OFF, the menu is always there and will not disappear. Please use the left/right button to set.
 - PTZ AUTO STOP: The speed dome will stop all the PTZ operations when there is no command for the specified time. It includes various setups. Please use the left/right button to set.
- NEXT PAGE: It includes: HEATER CONTROL and PTZ CORRECTION. Move the cursor to the item and then click the confirm button to set. .
 - HEATER CONTROL: There are three options: NO/NC/Auto. Move the cursor to the item and then click the confirm button to set. .
 - PTZ CORRECTION: It is to set speed dome self-diagnosis. Use the left/right button to set on/off. Please restart the device to activate new setup.
- BACK: Go back to previous menu.
- EXIT: Log out system menu.

4.4.4.1 Preset Setup

PRESET NO :	1
TITLE :	PRESET1
SETTING	
CALL	
BACK	EXIT

Move the cursor to PRESET button and then click confirm button to go to set interface.

- **PRESET NO:** Please use left/right key to modify preset number. The different protocols support different preset values.
- **TITLE:** Title text is the label used for you to identify the camera. System will automatically name a title for the camera.
- **SETTING:** Please input preset number first and then select the monitor zone. Please move the cursor to setting and click confirm button. The system will pop up a message: PRESET: ***. Here *** means preset number. And the SETTING column pops up an OK. Now you successfully added a preset. Please note, you need to enable display preset title function first (Main menu->display setting->preset title). Repeat the above procedures to set more presets. Once you want to modify a preset, you can input the preset number you want to modify and then follow the above steps to set the preset. You can successfully modify a preset content.
- **CALL:** Here is to recall preset. Move the cursor to PRESET NO and then input corresponding preset value. Then move the cursor to CALL and then click confirm button to go to a preset.
- **BACK:** Go back to previous menu.
- **EXIT:** Log out system menu.

For PELCO protocol user, please refer to the following special functions:

- **Call preset:** Call preset 28 or preset 95 to go to dome menu. Call preset 29 or preset 99 to go to scan. Call preset 24 or preset 81 to go to pattern. Call preset 25 or preset 82 to go to tour. Call preset 30 or preset 96 to stop scan or pattern. Call preset 31 or preset 83 to begin rotation. Call preset 33 to enable PTZ 180 degrees rotation. Call preset 34 to set dome position as 0.
- **Set preset:** Set preset 26 or 92 to set scan left limit. Set preset 27 or 93 to set scan right limit. Set preset 22 or 79 to begin record. Set preset 23 or 80 to stop record.

4.4.4.2 Pan

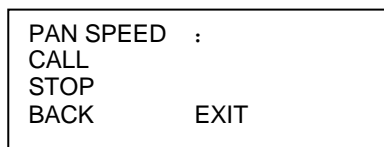

Move the cursor to PAN button and then click confirm button to go to setup interface.

- **PAN SPEED:** Set dome rotation speed. Please use the left/right button on the keyboard or in the speed dome terminal menu to set.
- **CALL:** Move the cursor to call item and then click confirm button. The dome begins 360 degrees continuous rotation.
- **STOP:** Highlight stop item and then click confirm button. The dome stops rotation.
- **BACK:** Go back to previous menu.
- **EXIT:** Log out system menu.

4.4.4.3 Scan

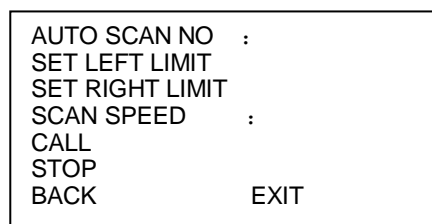

Move the cursor to SCAN button and then click confirm button.

- AUTO SCAN NO: Here is to set auto scan number. Please use the left/right button on the keyboard or in the speed dome terminal menu to set.
- SET LEFT LIMIT: Here is to set camera left address. Click confirm button to save current setup.
- SET RIGHT LIMIT: Here is to set camera right address. Click confirm button to save current setup.
- SCAN SPEED: Please use the left/right button on the keyboard or in the speed dome terminal menu to set.
- CALL: Please input auto scan number first, and then please move the cursor to CALL and click confirm button to activate auto scan function.
- STOP: Here is to terminate auto scan function.
- BACK: Go back to previous menu.
- EXIT: Log out system menu.

4.4.4.4 Tour

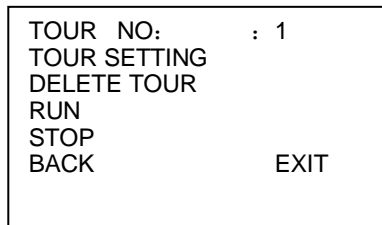

Move the cursor to highlight TOUR item and then click confirm button to go to set interface.

- TOUR NO : Here is to set tour number. Please use the left/right button on the keyboard or in the speed dome terminal menu to set.
- TOUR SETTING: Move the cursor to tour setting item and then click confirm button. You can see the following interface. Here you can add or remove the preset, and set the corresponding dwell time and call speed.

NO	PRESET	DWELL	SPEED
01	000	005	013
02	000	005	013
03	000	005	013
04	000	005	013
05	000	005	013
06	000	005	013
07	000	005	013
BACK			EXIT

- DWELL: Here is to set dwell time. Please use the left/right button on the keyboard or in the speed dome terminal menu to set.
- SPEED: Here you can set the speed value.

When you move the cursor to one tour number, you can use left/right button to turn the page.

When you move the cursor to one tour number, please click confirm button to set the tour. Please use up/down button to set preset number, dwell time and speed. Use the left/right button to go to the next tour. Click confirm button you can exit the setup. After you completed the setup, move the cursor to back button to go to the previous interface.

- DELETE TOUR: Here is to delete a tour. Input tour number in TOUR NO and then move the cursor to DELETE TOUR, click confirm button to delete.
- CALL: Here is to activate tour. Input tour number in tour NO and highlight CALL, click confirm button to activate touring.

- STOP: Here is to terminate touring.
- BACK: Go back to previous menu.
- EXIT: Log out system menu.

4.4.4.5 Pattern

PATTERN NO:	: 1
PROGRAM START	
PROGRAM STOP	
CALL	
STOP	
BACK	EXIT

Pattern function can memory PTZ operation and camera focus zoom in and zoom out.

From the start position, dome begins auto movement repeatedly.

Move the cursor to PATTERN and click confirm button.

- PATTERN NO: Here is to set pattern number. Please click left/right key to configure.
- PROGRAM START: Here is to memorize pattern starting point. An icon OK pops up in screen to prompt you system begins memory pattern.
- PROGRAM STOP: Here is to set pattern stop point. After all the movement, move the cursor to PROGRAM STOP and then click confirm button. Now you have set one pattern. System pops up an icon OK to prompt you system has memories one pattern.
- CALL: Here is to activate pattern. Input pattern number, move the cursor to CALL and click confirm button, system begins running pattern.
- STOP: Here is to stop current pattern. Input pattern number, move the cursor to STOP and click confirm button. System stops current pattern.
- BACK: Go back to previous menu.
- EXIT: Log out system menu.

Note:

- The dwell time between two orders should be less than one minute, otherwise system will set to default value as one minute.
- After click PROGRAM STOP, do not click CALL button before icon “●” disappears completely.
- Any manual operation during the pattern procedure will terminate current dome pattern operation.

4.4.4.6 Idle Function

IDLE FUNC	: OFF
IDLE TIME	: 10MIN
IDLE ACTION	: PRESET
PARAMETER	: NONE
SAVE	
BACK	EXIT

When there is no available command for specified time, dome automatically goes on the previous set functions.

- IDLE FUNCTION : There are two modes ON/OFF. Please use left/right key to set.

- IDLE TIME: System idle period. Please use the left/right button on the keyboard or in the speed dome terminal menu to set.
- IDLE ACTION: There are several functions you can select: NONE/PRESET/SCAN/TOURING/PATTERN. Please use the left/right button on the keyboard or in the speed dome terminal menu to set.
- PARAMETER: It is to set idle motion SN. System can implement the corresponding action when it is idle for the specified period. Click the left/right button to set.
- SAVE: Move the cursor to SAVE and click confirm button to save current setup.
- BACK: Go back to previous menu.

4.4.4.7 Time Task (Schedule task)

TASK NO	:	1
TIME TASK	:	OFF
TASK SETTING		
TASK INFORMATION		
DELETE TASK		
BACK		EXIT

- TASK NO: Here you can set task number. Please use the left/right button to set.
- TIME TASK: The schedule task allows the speed dome to implement corresponding setup during the specified time. There are two options: on/off. Please use the left/right button on the keyboard or in the speed dome terminal menu to set.
- TASK SETTING: Here you can set task time, operation, operation SN and etc. Please click the confirm button to go to the fourth menu to set.
- TASK INFORMATION: Here you can view the corresponding task information. Please click the confirm button to go to the fourth menu to set.
- DELETE TASK: Please input the task number to be deleted in the TASK NO, and then move the cursor to the current item. Click the confirm button, you can remove all the setups in the current schedule task. Now current task is null.
- BACK: Go back to the previous menu.
- EXIT: Log out the system menu.

Task Setting

Move the cursor to the TASK SETTING and then click the confirm button, you can set the task begin time, end time, action and etc.

WEEK	:	1
START TIME	:	OFF
END TIME		
RUN ACTION		
PRESET NO		
SAVE		
BACK		EXIT

- WEEK: Here you can set the week information. Please use the left/right button to set. You can set for one day, or you can set for the whole week.
- START TIME: Here you can set the task begin time. Move the cursor to current item and then click confirm button to set the time. Please use the up/down button to set the detailed value and then use left/right button to go to the next setup item. After you completed the setup, please click confirm button to exit start time setup and then move the cursor to the SAVE button to save current setup.

- END TIME: Here you can set the task end time. Move the cursor to current item and then click confirm button to set the time. Please use the up/down button to set the detail value and then use left/right button to go to the next setup item. After you completed the setup, please click confirm button to exit end time setup and then move the cursor to the SAVE button to save current setup.
- TASK ACTION: The option here includes: none/tour/scan/preset/patter and etc. Please use left/right button to set.
- OPERATION NO: It is the corresponding serial number of the schedule task. The number here may vary due to different action types.
- BACK: Go back to the previous menu.
- EXIT: Log out the system menu.

Task Information

Move the cursor to the TASK INFORMATION and then click the confirm button to go to the following interface. Here you can see the corresponding task information. Click the confirm button again, you can exit current interface.

NO	TIME	ACTION
1	ALL 00: 00—00: 00	SC001 OFF
2	ALL 00: 00—00: 00	SC001 OFF
3	ALL 00: 00—00: 00	SC001 OFF
4	ALL 00: 00—00: 00	SC001 OFF
5	ALL 00: 00—00: 00	SC001 OFF
6	ALL 00: 00—00: 00	SC001 OFF
7	ALL 00: 00—00: 00	SC001 OFF
8	ALL 00: 00—00: 00	SC001 OFF

4.4.4.8 Next Page

Move the cursor to the NEXT PAGE and then click the confirm button, you can go to the third menu to set the PTZ SPEED, SET ZERO, POWER UP and etc.

PRIVACY MASK	:	
PTZ SPEED	:	
SET ZERO		
POWER UP		
MENU PASSWORD		
MENU IDLE		
PTZ AUTO STOP		
NEXT PAGE		
SAVE		
BACK		EXIT

HEATER CONTROL		
PTZ CORRECTION	:	OFF
BACK		EXIT

- PRIVACY MASK: Here you can set the privacy mask number and etc. It includes the third menu. Please move the cursor to the current item and then click the confirm button to go to the next interface.
- PTZ SPEED: It is to set PTZ speed. Please use the left/right button to set.

- SET ZERO: It is to set the PTZ initial position. Please move the PTZ to the corresponding position and then click the confirm button to complete the setup.
- POWER UP: It is to set the PTZ action when the speed dome boots up. Click the confirm button to go to the next interface. To set
- MENU PASSWORD: It is to set the password to go to the PTZ menu. Click the confirm button to go to the next interface. To set
- MENU IDLE: If current setup is ON, once you open the menu and leave it idle for specified period, the menu may automatically disappear. If current setup is OFF, the menu is always there and will not disappear. Please use the left/right button to set.
- PTZ AUTO STOP: The speed dome will stop all the PTZ operations when there is no command for the specified time. It includes various setups. Please use the left/right button to set.
- HEATER CONTROL: There are three options: NO/NC/Auto. The default setup is auto.
- PTZ CORRECTION: It is to set speed dome self-diagnosis. Use the left/right button to set on/off.
- BACK: Go back to the previous menu.
- EXIT: Log out the system menu.

Privacy Mask

Move the cursor to PRIVACY MASK and click confirm button, system goes to privacy mask setup interface.

PRIVACY NO	:	1
PRIVACY MASKING	:	OFF
SETTING		
BACK		EXIT

RESIZE	:	↑
SAVE		
BACK		EXIT

Note:

- For security reasons, please set privacy zone a little bit larger than the privacy object size.
- Each time, after modifications you need to move the cursor to SAVE button and then click confirm button to get all setup activated. Otherwise, privacy zone may not move correspondingly with the object.

Please enter privacy mask menu.

Move the cursor to PRIVACY NO, please use left/right key to set different privacy zones.

For example, shift to 001 section and then move the cursor to SETTING.

Secondly, click OK button to go to the setup interface. Now there is a privacy zone in the screen centre.

Operate PTZ to move the camera screen so that the centre of the object you want to shield is overlaying with the centre of the screen.

Thirdly, move the cursor to RESIZE and then click left and right key to adjust privacy zone direction and size.

Fourthly, move the cursor to SAVE and then click confirm button to exit. Please note you need to click SAVE button to save current privacy mask setup so that the privacy mask region can move along with the PTZ movement to always cover the object you want to shield.

- PRIVACY NO: Here is to set privacy mask zone. Please use the left/right button on the keyboard or in the speed dome terminal menu to set. You can call corresponding privacy mask zone number if you have successfully set one.
- PRIVACY MASKING: There are two settings: on and off. Please go to the corresponding privacy mask zone and click left/right button to set.
- RESIZE: It is to adjust the privacy zone size. Move the cursor to current item and use the left/right button on the keyboard or in the speed dome terminal menu to set. Please continue pressing direction

button to widen or narrow zone size. ← is to narrow the horizontal width and → is to widen the horizontal width. ↑ is to widen vertical height and ↓ is to narrow the vertical height.

- SAVE: Here is to save user setup.
- BACK: Go back to previous menu.
- EXIT: Log out system menu.

Power Up

Move the cursor to the POWER UP item and then click the confirm button, you can go to the fourth menu.

POWER UP	:	1
PARAMTER	:	OFF
BACK	:	EXIT

- POWER UP: It is to set the PTZ operation when the speed dome boots up. The option includes: NONE/AUTO/SCAN/PRESET/PATTERN/TOUR and etc. Please use the left/right button to set.
- PARAMTER: Here you can set the serial number of the corresponding operation such as the scan, preset, pattern, tour. Please use the left/right button to set.
- BACK: Go back to the previous menu.
- EXIT: Log out the system menu.

Menu Password

Move the cursor to the MENU PASSWORD and the click the confirm button to go to the fourth menu.

PASSWORD :	PASSWORD:
SETTING :	1 2 3 4 5
BACK EXIT	6 7 8 9 0
	→ SAVE BACK

- PASSWORD: Enable this function here so that you set password is valid. This function is on by default after you set password.
- SETTING: Click the confirm button to go to the password setup interface. Please use the left/right button to set the value and then click the confirm button to confirm current option. Move the cursor to the SAVE button and then click the confirm button to save current setup. Click the BACK button to go to the previous menu.
- BACK: Go back to the previous menu.
- EXIT: Log out the system menu.

If you have forgot your password. After three times of login failure, system may pop up an 8-digit internal code. Please contact our technical engineer for help.

Heater Control

Move the cursor to highlight HEATER CONTROL button and then click confirm button. You can go to the 4th menu.

HEATER CONTROL	:	AUTO
OPEN TEMPERATURE	:	
COLSE TEMPERATURE	:	
BACK	:	EXIT

- HEATER CONTROL: It is to set temperature control mode. It includes three modes: auto/normal open/normal close. Please use the left/right button on the keyboard or in the speed dome terminal menu to set.
- OPEN TEMPERATUREP: This function is on when the heater control mode is auto. It is for you to set temperature to enable the heater.
- CLOSE TEMPERATURE: This function is on when the heater control mode is auto. It is for you to set temperature to disable the heater.
- BACK: Go back to the previous menu.
- EXIT: Log out the system menu.

4.4.5 IR Light Setting

IR SENSITIVITY:	: 4
IRLIGHT CTRL	: ZOOM PRI
NEAR LIGHT	: 50
FAR LIGHT	: 50
IRLIGHT COMP	: 3
BACK	EXIT

Move the cursor to highlight IR LIGHT SETTING button and then click confirm button.

- IR SENSITIVITY: Here you can enable the IR light sensitivity function.
- IR LIGHT CTRL: There are three options: Zoom rate has the higher priority and manual. Please use the left/right button to set.
- NEAR LIGHT: It is the medium and near light brightness. **This function is valid in MANUAL mode.**
- FAR LIGHT: It is the far light brightness. **This function is valid in MANUAL mode.**
- IR LIGHT COMPENSATION: It is the whole compensation level of the IR light. **This function is valid when the zoom rate has the higher priority.**
- BACK: Go back to the previous menu.
- EXIT: Log out the system menu.

4.4.6 Wiper setting

WIPER MODE	: TIME
START TIME	: 07H 00M
STOP TIME	: 19H 00M
INTERVAL	: 10S
WIPER CTRL	: STOP
SAVE	
BACK	EXIT

Move the cursor to highlight WIPER SETTING button and then click confirm button.

- WIPER MODE: It is to set the zoom camera wiper mode. It includes two modes: Manual/schedule. Use the left/right button to set.
- START TIME: It is to set wiper enable start time. Use the left/right button to set. **Please note this function is only valid when the wiper mode is schedule.**
- END TIME: It is to set wiper enable end time. Use the left/right button to set. **Please note this function is only valid when the wiper mode is schedule.**
- INTERVAL: It is to set the period between two operations. Use the left/right button to set.
- WIPER CONTROL: It is to set wiper operation. It includes: enable/stop/once only. Use the left/right button to set.
- SAVE: Save current settings.
- BACK: Go back to the previous menu.

- EXIT: Log out the system menu.

4.5 Dome Abnormal Phenomenon Operation

4.5.1 Restore to Factory Default Setup

From main menu-> SYSTEM INFORMATION, move cursor to FACTORY DEFAULT and click confirm button. Dome will reboot and all the setups restore to factory default setup.

4.5.2 PTZ Movement is not smooth

From menu to SYSTEM INFORMATION, move cursor to RESTART and click confirm button. This reboot will not modify all activated setup (such as preset, tour and pattern)

5 Cable Connection

5.1 Combination Cable Connection

The speed dome combination cable includes network cable, audio/video cable connection port, RS485 connection port, alarm input and output port. Please refer to the label for detailed information.

- **Please note the IE6 does not support alarm upload function. Please use IE7 or higher version.**
- **If it is your first time to boot up the WEB on the Windows 7 OS, please right click the Internet Explorer icon on the desktop and then select “Run as Administrator”.**
- **Slight difference may be found in the port amount since some functions are optional.**

Name		Function
POWER GND		Power port. Connect to the power cable. GND: ground end.
485A 485B		RS485 remote control.
AUDIO	OUT	Audio output port.
	GND	Ground port.
	IN	Audio input port.
VIDEO	GND	Ground port.
	OUT	Video output port.
LAN		Network port. Connect to network cable.
ALARM IN		<ul style="list-style-type: none"> ● Seven alarm input channels. It is to receive relay signal from the external alarm source. You can go to dome menu to activate specified preset or patter. ● When the activation mode is NO (normal open), dome alarms when there is low voltage. High voltage will not activate the alarm. ● When the activation mode is NC (normal close), dome alarms when there is high voltage. Low voltage will not activate the alarm. <p>Note:</p> <ul style="list-style-type: none"> ● Dome alarm input message is ground mode. ● Dome alarm input signal are two modes: normal open and normal close. ● The default setup: 7-channel alarm input.
	GND	Alarm input ground end.
ALARM OUT	2	<ul style="list-style-type: none"> ● Two alarm output channels. When there is an alarm from current channel, system activates relay or not. ● Alarm output relay default setup is NO. ● The default setup: 2-channel alarm output.

5.2 System Layout

5.2.1 System Connection

Please refer to Figure 5-1 for system connection information.

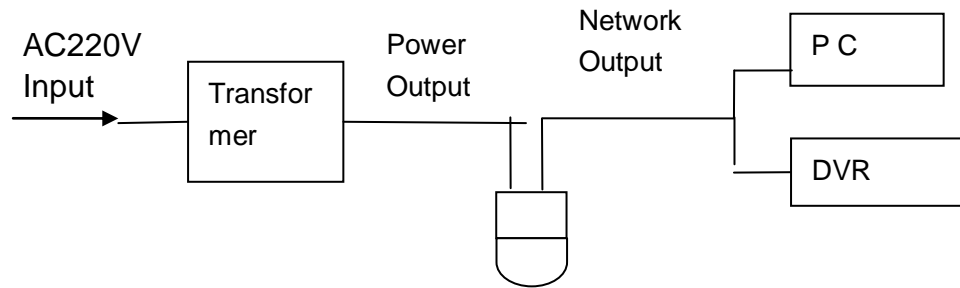

Figure 5-1

5.2.2 Alarm Connection

Please refer to Figure 5-2 for alarm connection information.

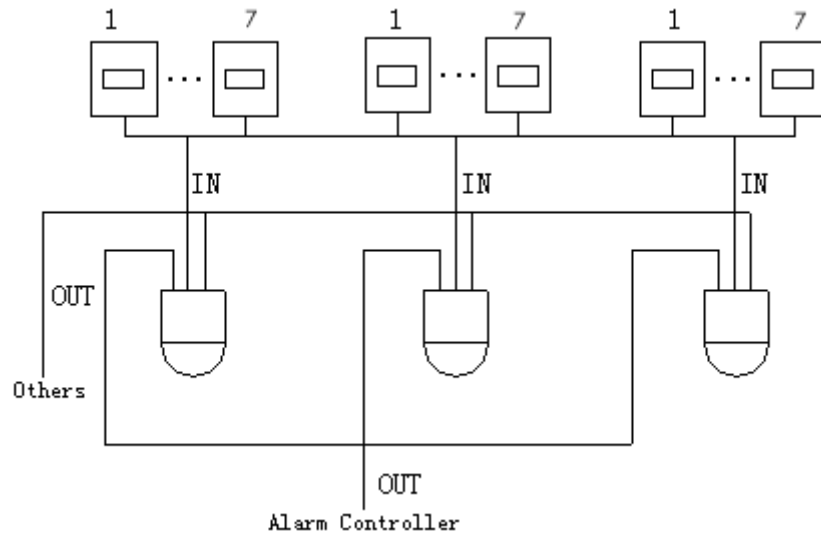

Figure 5-2

6 FAQ

6.1 Daily Maintenance

Please clean dome cover regularly to get vivid image.

Handle the cover with care. Use water to wash. Don't use cloth to clean.

Note:

The sweat from your hand may erode plating surface, your nail may scrape dome cover resulting in blur image.

6.2 Problems and Solutions

SYMPTOM	CAUSE	SOLUTION
No self-diagnosis, no video signal when I connect dome to power.	Red LED is not on. <ul style="list-style-type: none"> Your power supplying does not apply to the power. Or connection is too loose. Power off or transformer problem. 	<ul style="list-style-type: none"> Check power is connected or properly earthed. Check power supply condition or check transformer.
	Red LED light on the power board is on <ul style="list-style-type: none"> Power supplying is low Something wrong with power board. 	<ul style="list-style-type: none"> Use multimeter to check dome load. Please contact retailer to replace power board.
No self diagnosis. There is a noise	Power supplying is inadequate.	Replace power supplying.
	Mechanical malfunction.	Need electrical engineer help.
Video signal is not successive	Circuit connection is too loose.	Connect tightly.
	Video switch or power problem	Need electrical engineer help.
Video is not clear.	Focus is in manual mode.	Control manually.
	Dome cover is dirty.	Wash dome cover
During camera switch, there is a tilt movement in the monitor.	Camera power is not in the same Phase.	When several domes are connected to one transformer, please connect the transformer output cable to the domes' same side.

7 Appendix I Lightning Protection and Surge Protection

This series speed dome adopts TVS lightning protection technology. It can effectively prevent damages from various pulse signals below 1500W, such as sudden lightning and surge. While maintaining your local electrical safety code, you still need to take necessary precaution measures when installing the speed dome in the outdoor environment.

- The distance between the signal transmission cable and high-voltage device (or high-voltage cable) shall be at least 50 meters.
- Outdoor cable layout shall go under the penthouse if possible.
- For vast land, please use sealing steel tube under the land to implement cable layout and connects one point to the earth. Open floor cable layout is forbidden.
- In area of strong thunderstorm hit or near high sensitive voltage (such as near high-voltage transformer substation), you need to install additional high-power thunder protection device or lightning rod.
- The thunder protection and earth of the outdoor device and cable shall be considered in the building whole thunder protection and conform to your local national or industry standard.
- System shall adopt equal-potential wiring. The earth device shall meet anti-jamming and at the same time conforms to your local electrical safety code. The earth device shall not short circuit to N (neutral) line of high voltage power grid or mixed with other wires. When connect the system to the earth alone, the earth resistance shall not be more than 4Ω and earth cable cross-sectional area shall below 25 mm². See Figure 7-1.

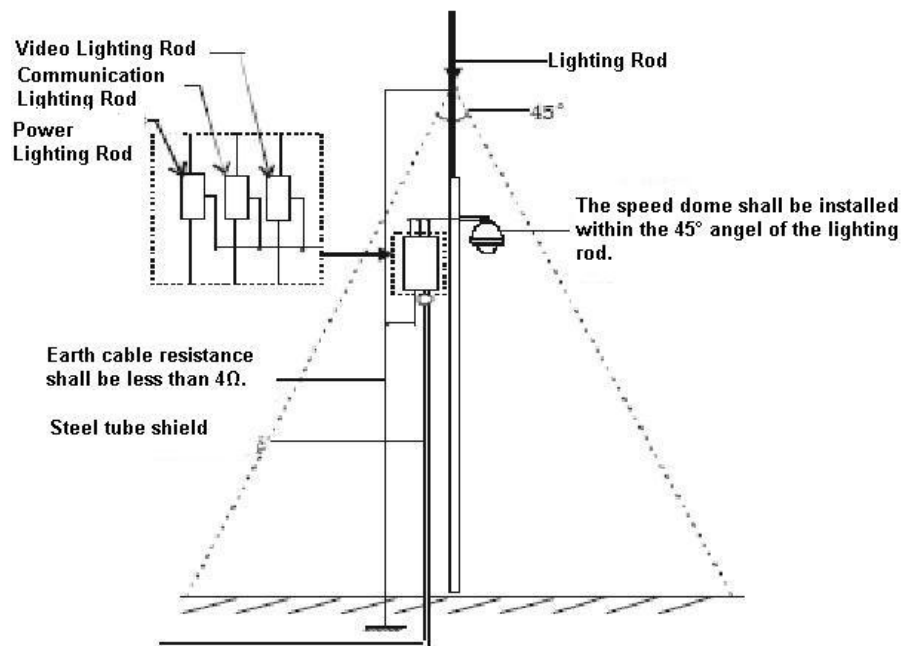

Figure 7-1

8 Appendix 2 Toxic or Hazardous Materials or Elements

Component Name	Toxic or Hazardous Materials or Elements					
	Pb	Hg	Cd	Cr VI	PBB	PBDE
Sheet Metal	○	○	○	○	○	○
Plastic Parts	○	○	○	○	○	○
PCB	○	○	○	○	○	○
Housing	○	○	○	○	○	○
Camera Driver	○	○	○	○	○	○
Bearing	○	○	○	○	○	○
Connection Cable	○	○	○	○	○	○
Motor (If possible)	○	○	○	○	○	○
Power (If possible)	○	○	○	○	○	○
Bracket (If possible)	○	○	○	○	○	○
Accessories	○	○	○	○	○	○

Note

O: Indicates that the concentration of the hazardous substance in all homogeneous materials in the parts is below the relevant threshold of the SJ/T11363-2006 standard.

X: Indicates that the concentration of the hazardous substance of at least one of all homogeneous materials in the parts is above the relevant threshold of the SJ/T11363-2006 standard. During the environmental-friendly use period (EFUP) period, the toxic or hazardous substance or elements contained in products will not leak or mutate so that the use of these (substances or elements) will not result in any severe environmental pollution, any bodily injury or damage to any assets. The consumer is not authorized to process such kind of substances or elements, please return to the corresponding local authorities to process according to your local government statutes.

Note

- **This manual is for reference only. Slight difference may be found in the user interface.**
- **All the designs and software here are subject to change without prior written notice.**
- **All trademarks and registered trademarks are the properties of their respective owners.**
- **If there is any uncertainty or controversy, please refer to the final explanation of us.**
- **Please visit our website or contact your local service engineer for more information.**

Dahua Technology Co.,Ltd

Address: No.1199 Bin'an Road, Binjiang District, Hangzhou, China.

Postcode: 310053

Tel: +86-571-87688883

Fax: +86-571-87688815

Email:overseas@dahuatech.com

Website: www.dahuatech.com