

# **ITC237-PW1A-IRZ User's Manual**

**Version 1.0.0**

## **Welcome**

Thank you for purchasing our HD intelligent traffic camera!

This user's manual is designed to be a reference tool for your system.

Please read the following safeguard and warnings carefully before you use this series product!

Please keep this user's manual well for future reference!

# Important Safeguards and Warnings

## 1 . Electrical safety

All installation and operation here should conform to your local electrical safety codes.

The power shall conform to the requirement in the SELV (Safety Extra Low Voltage) and the Limited power source is rated 90-240V.

We assume no liability or responsibility for all the fires or electrical shock caused by improper handling or installation.

## 2 . Transportation security

Heavy stress, violent vibration or water splash are not allowed during transportation, storage and installation.

Please keep package material well in case you need to send it back to your local retailer or manufacturer for maintenance work.

Non-original package material may result in device damage during the transportation.

## 3 . Installation

Do not apply power to the camera before completing installation.

Please install the proper power cut-off device during the installation connection in case there is any emergency situation.

Always follow the instruction guide the manufacturer recommended.

## 4 . Qualified engineers needed

Do not replace the button cell on the internal circuit of the main board without the prior authorization. Improper button cell type may result in risk of explosive.

Please process the used button cells properly according to its usage instruction.

All the examination and repair work should be done by the qualified service engineers.

We are not liable for any problems caused by unauthorized modifications or attempted repair.

## 5 . Environment

This series camera should be installed in a cool, dry place away from direct sunlight or strong light, inflammable, explosive substances and etc.

The working temperature ranges from  $-30^{\circ}\text{C}$  ~ to  $+60^{\circ}\text{C}$ . Do not touch the external metal part of the device when it is working in harsh environments.

Please keep it away from the electromagnetic radiation object and environment.

Please keep the sound ventilation.

Do not allow the water and other liquid falling into the camera.

Usually we recommend thunder-proof device to prevent thunder strike.

The GND port of the product shall be grounded to further enhance the reliability of the device.

## **7. Daily Maintenance**

Please shut down the device and then unplug the power cable before you begin daily maintenance work.

Use the dry soft cloth to clean the device.

If there is too much dust, please use the water to dilute the mild detergent first and then use it to clean the device. Finally use the dry cloth to clean the device.

## **8. Accessories**

Be sure to use all the accessories recommended by manufacturer.

Before installation, please open the package and check all the components are included.

Contact your local retailer ASAP if something is broken in your package.

You may install the device if nothing is missing or broken in your package.

# Table of Contents

1	General Introduction .....	1
1.1	Overview .....	1
1.2	Features .....	1
2	Framework.....	3
2.1	Appearance.....	3
2.2	Cable Structure .....	3
2.2.1	Combination Cable .....	3
3	Cable Installation .....	5
4	System Network .....	6
5	Web Operation .....	7
5.1	Network Connection.....	7
5.2	Login and Main Interface.....	7
6	Quick Configuration Tool .....	10
6.1	Overview .....	10
6.2	Operation .....	10
7	Technical Specification .....	13
8	FAQ .....	15

# 1 General Introduction

## 1.1 Overview

This product is a snapshot camera for parking lot. It has advanced vehicle detection and recognition technologies to snapshot vehicle, plate which co-operate with rear-end server and AUX device to manage entrance/exit and spots in parking lot.

This product is applied to parking lot management system.

## 1.2 Features

<b>White List</b>	<ul style="list-style-type: none"><li>● Set whether vehicle to have open gate right or not.</li></ul>
<b>Cutout</b>	<ul style="list-style-type: none"><li>● When it snapshots one vehicle, it also cutout plate part of that snapshot.</li></ul>
<b>OSD</b>	<ul style="list-style-type: none"><li>● Set picture OSD info and position, video channel related info can be set in camera setup page.</li></ul>
<b>User Management</b>	<ul style="list-style-type: none"><li>● Different user rights for each group and you may modify the setup anytime.</li><li>● The user right cannot exceed the right setup.</li><li>● Support 2-level user.</li></ul>
<b>Log Management</b>	<ul style="list-style-type: none"><li>● Support 1024 log.</li><li>● Support account right setup.</li></ul>
<b>Storage Function</b>	<ul style="list-style-type: none"><li>● Support FTP.</li></ul>
<b>Alarm Function</b>	<ul style="list-style-type: none"><li>● For camera abnormality, it can send alarm via network, such as storage damage.</li><li>● Real-time respond to external alarm input( within 200MS) as user pre-defined activation setup and exert corresponding message in screen and audio prompt(allow user to pre-record audio file).</li></ul>
<b>Network Monitor</b>	<ul style="list-style-type: none"><li>● HD intelligent traffic camera supports one-channel A/V data transmit to network terminal and then decode. Allowed by the band width, delay is less than 500ms.</li><li>● Max supports 10 connections.</li><li>● Adopt the following A/V transmission protocol: HTTP, TCP, UDP, MULTICAST and RTP/RTCP and etc.</li><li>● Support web access, widely used in WAN.</li></ul>
<b>Recognition</b>	<ul style="list-style-type: none"><li>● Support plate, vehicle color recognition function.</li></ul>
<b>Network Management</b>	<ul style="list-style-type: none"><li>● Realize HD intelligent traffic camera configuration and management via Ethernet.</li><li>● Support device management via web.</li></ul>
<b>Peripheral Equipment</b>	<ul style="list-style-type: none"><li>● Support peripheral equipment management, each peripheral equipment control protocol and interface can be set freely.</li><li>● Support activation devices such as vehicle detector.</li></ul>
<b>Power Supplying</b>	<ul style="list-style-type: none"><li>● Support AC 24V input.</li></ul>
<b>Auto White Balance</b>	<ul style="list-style-type: none"><li>● The white balance refers to the camera to restore the white object color. It allows the camera to adjust the color temperature in indoor and</li></ul>

	outdoor environment.
<b>Auto Exposure</b>	<ul style="list-style-type: none"> <li>● System can automatically set shutter speed and iris value according to the snapshot video exposure condition.</li> </ul>
<b>Auto Gain</b>	<ul style="list-style-type: none"> <li>● To output the standard video signal in the different illumination environments, the amplifier needs to adjust in a wide range. The system can enhance the camera sensitivity in low illumination and enhance the video signal output to get the clear and high definition video.</li> </ul>
<b>Assistant Function</b>	<ul style="list-style-type: none"> <li>● Support video watermark function to avoid vicious video modification.</li> </ul>

## 2 Framework

### 2.1 Appearance

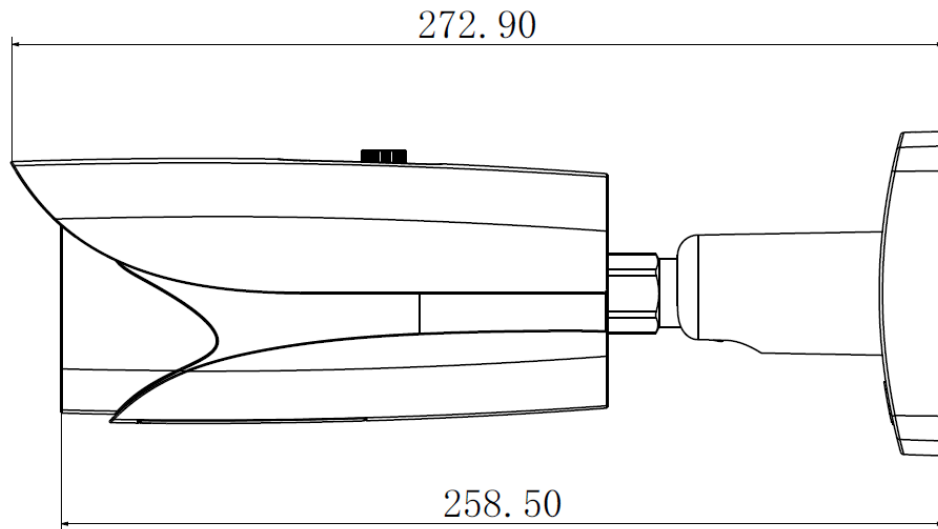

Figure 2- 1

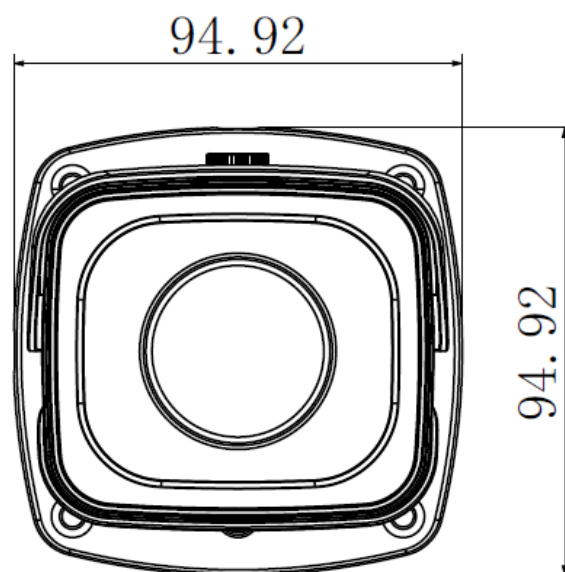

Figure 2- 2

### 2.2 Cable Structure

#### 2.2.1 Combination Cable

See Figure 2- 3 .



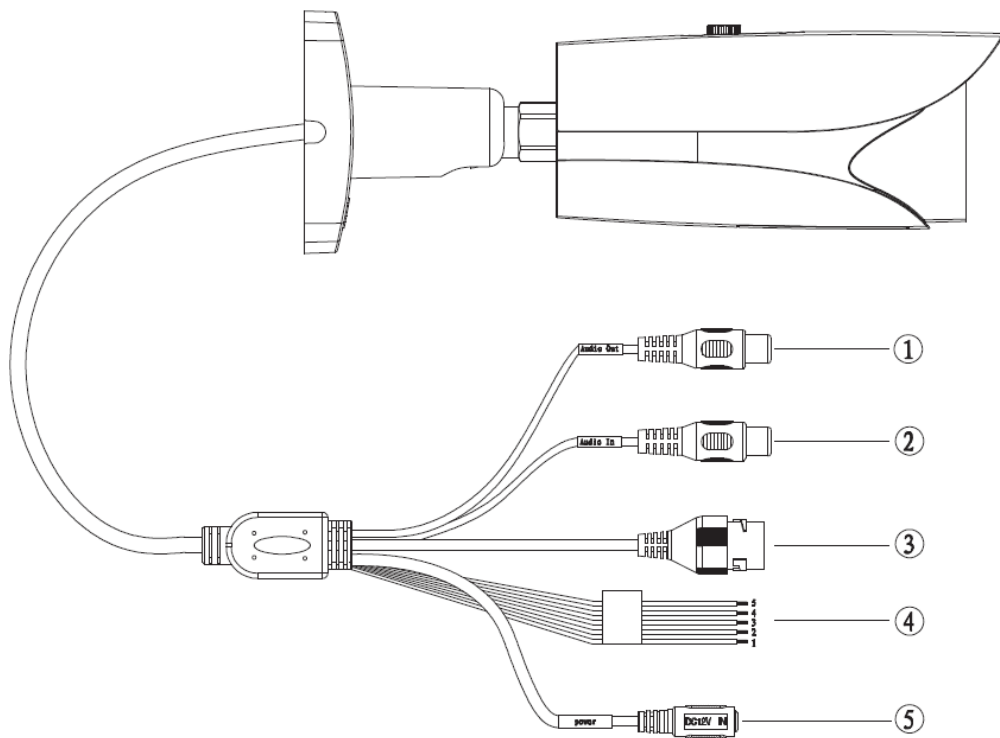

Figure 2- 3

No.	Port	Function	Function
①	Audio Out	Audio output port	Output audio signal (not available)
②	Audio In	Audio input port	Input audio signal (not available)
③	-	Network port	Connect to Ethernet.
④	ALARM_NO	Alarm output port	Output alarm signal
	ALARM_COM		
	ALARM_IN1	Alarm input port 1	Connect to 1-ch, as signal coil IO snapshot; connect to 1-ch and 2-ch. As dual coil IO snapshot
	ALARM_IN2	Alarm input port 2	
	ALARM_GND	Alarm input GND	
⑤	POWER	Power port	Input AC24V power

### 3 Cable Installation

Device cable installation is shown in Figure 3- 1.

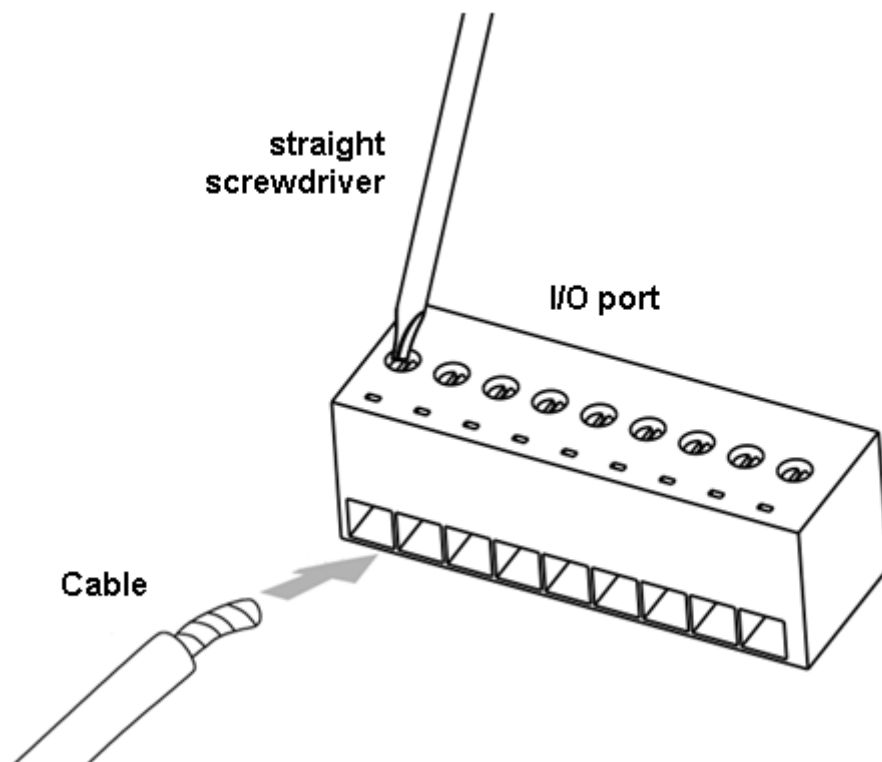

Figure 3- 1

Step 1. Use a small straight screwdriver to unfasten the screw on cable slot by counterclockwise rotation.

Step 2. Insert cable to corresponding slot.

Step 3. Fasten the screw with straight screwdriver by clockwise rotation.

Note:

If you want to remove cable, please unfasten the screw on cable slot by counterclockwise rotation, and pull out cable.

## 4 System Network

Please refer to

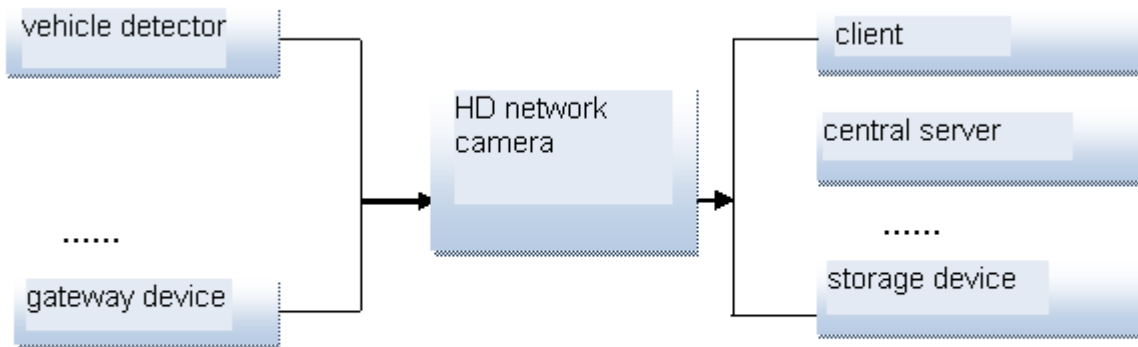

Figure 4-1 for system connection.

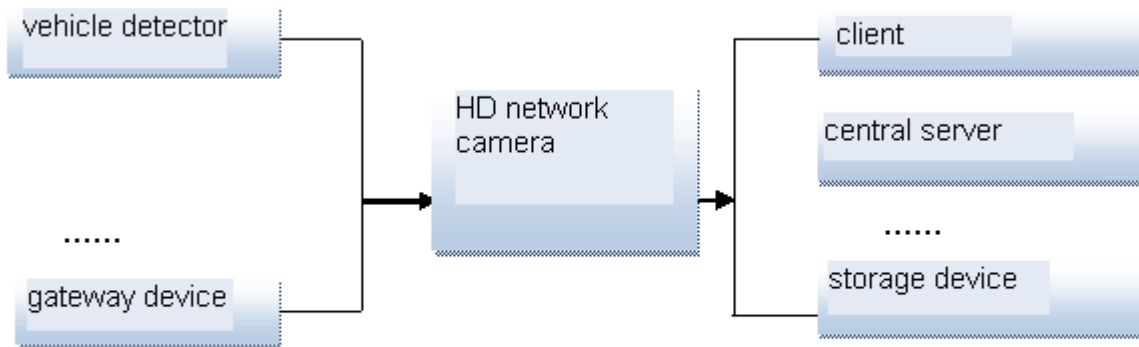

Figure 4-1

## 5 Web Operation

This series HD intelligent traffic camera product supports the Web access and management via PC.

Web client end includes several modules: monitor channel list, record search, alarm setup and etc.

### 5.1 Network Connection

Please follow the steps listed below for network connection.

- Make sure the HD intelligent traffic camera has connected to the network properly.
- HD intelligent traffic camera IP address and PC IP address shall be in the same network segment. If there is router, please set the corresponding gateway and subnet mask.
- Use order ping `***.***.***.***`(\* HD intelligent traffic camera address) to check connection is OK or not.

### 5.2 Login and Main Interface

Step 1. Open IE and input HD intelligent traffic camera address in the address bar.

For example, if your camera IP is 192.168.1.108, then please input `http:// 192.168.1.108` in IE address bar. See Figure 5- 1.

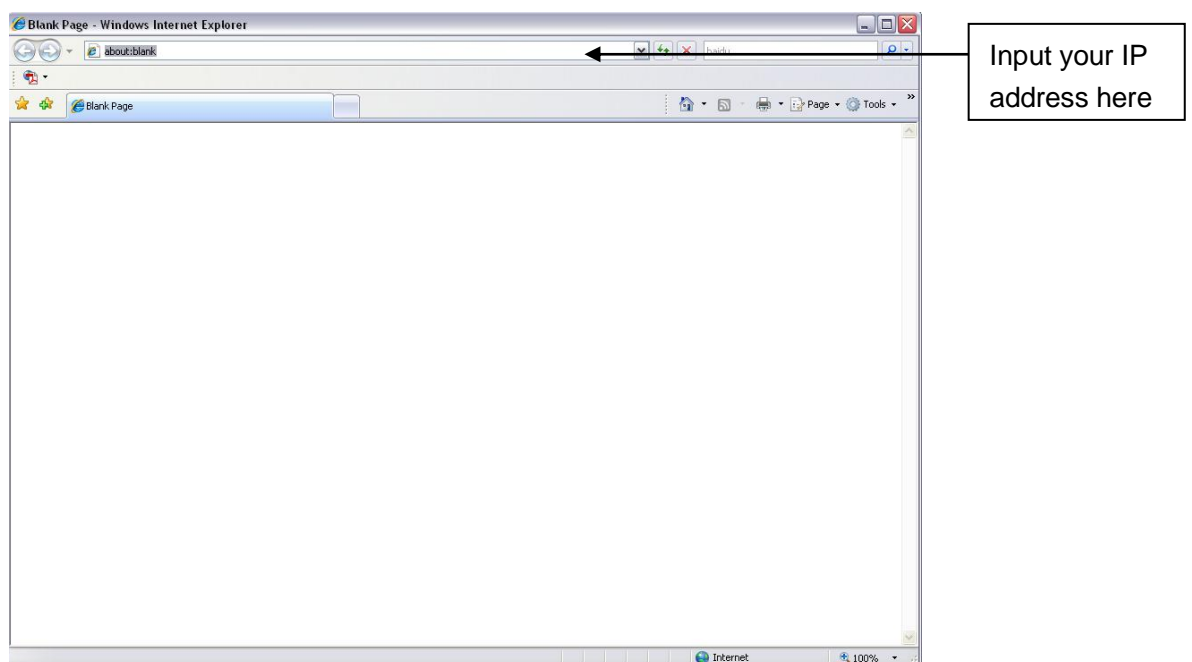

Figure 5- 1

Step 2. Select ACCEPT.

System pops up warning information to ask you whether install control webrec.cab or not. Please click OK button, system can automatically install the control. When system is upgrading, it can overwrite the previous Web too.

If you can't download the ActiveX file, please check whether you have installed the plug-in to disable the control download. Or you can lower the IE security level. See 错误! 未找到引用源。 .

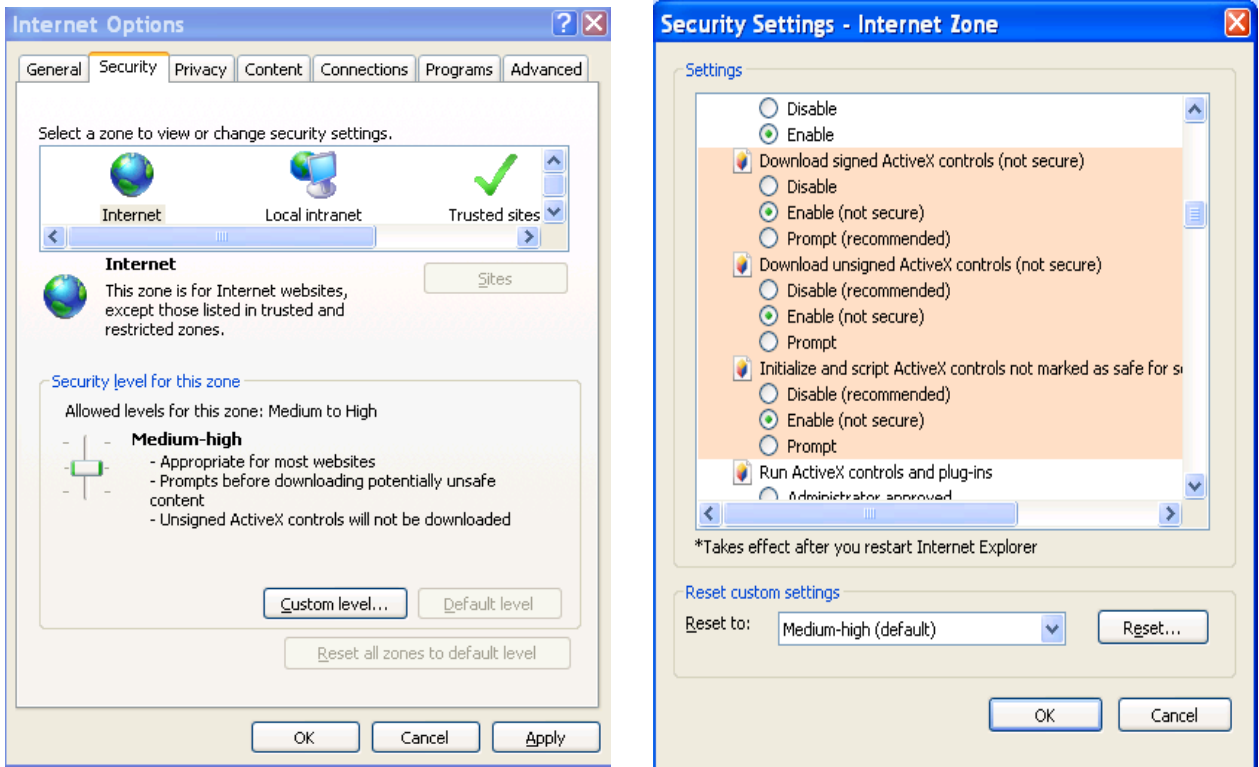

Figure 5- 2

After installation, the interface is shown as below. See Figure 5- 3.

Step 3. Please input your user name and password.

Default factory name is admin and password is admin.

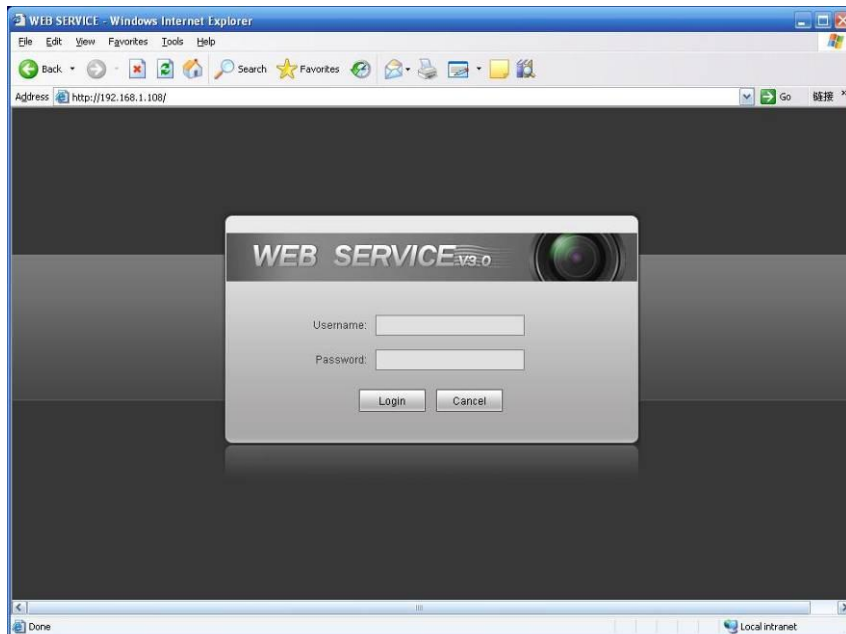

Figure 5- 3

After you logged in, you can see the main window. See Figure 5- 4.

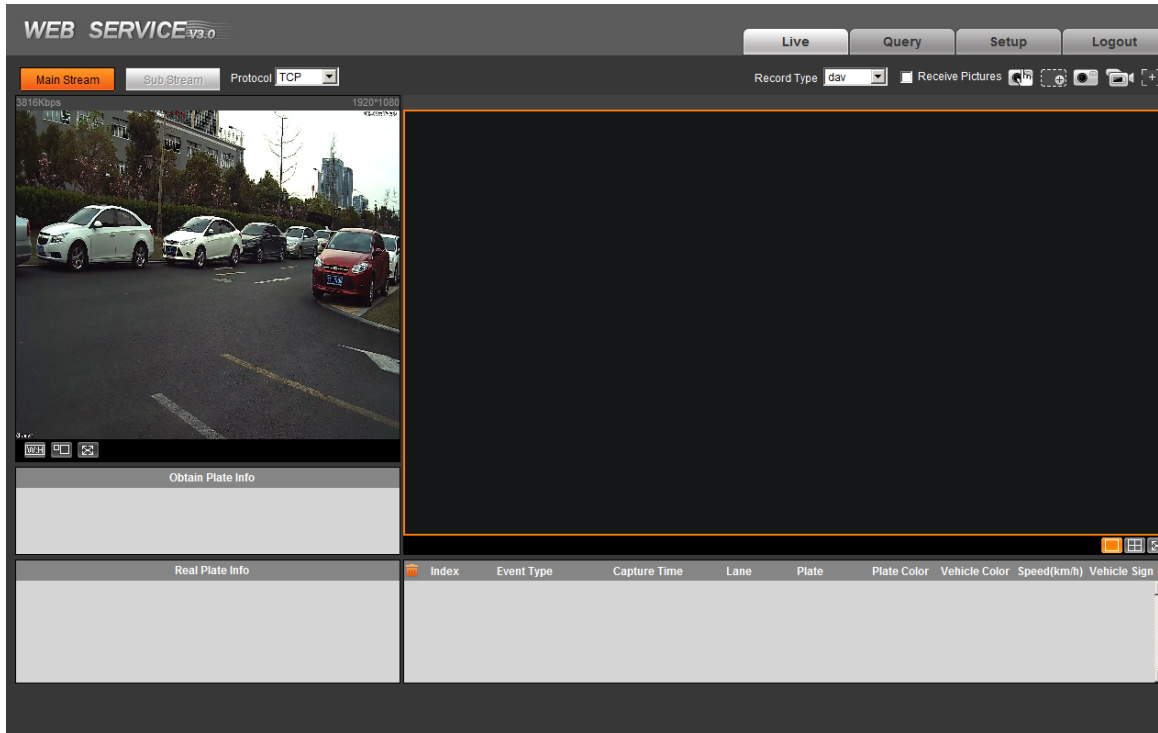

Figure 5- 4

Please refer to the Web Operation Manual included in the resource CD for detailed operation instruction.



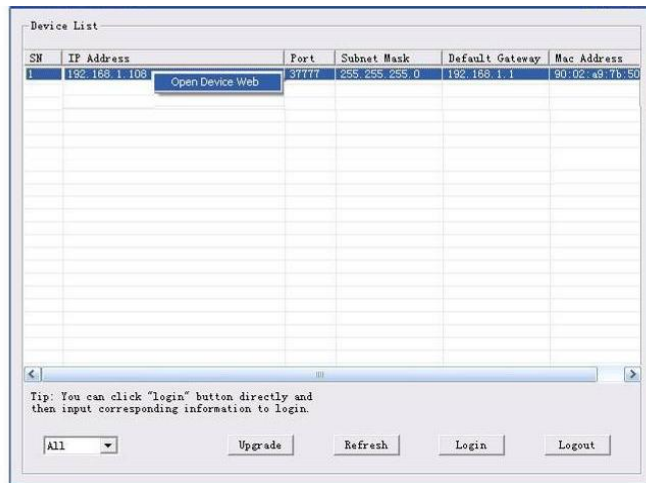

Figure 6- 2

Select the “Open Device Web” item; you can go to the corresponding web login interface. See Figure 6- 3.

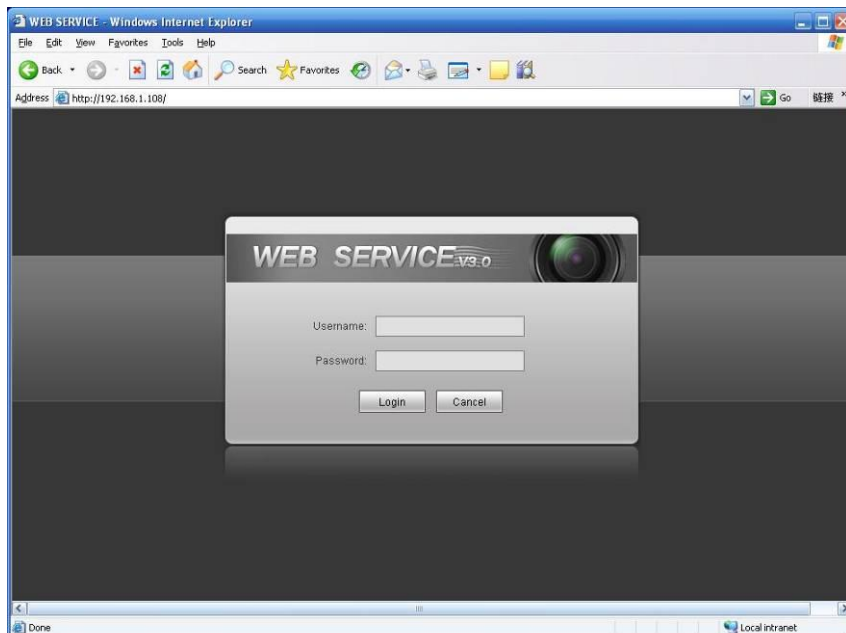

Figure 6- 3

If you want to modify the device IP address without logging in the device web interface, you can go to the configuration tool main interface to set.

- In the configuration tool search interface (Figure 6- 1), please select a device IP address and then double click it to open the login interface.
- Or you can select an IP address and then click the Login button to go to the login interface. See Figure 6- 4.

In Figure 6- 4, you can view device IP address, user name, password and port. Please modify the corresponding information to login.

Please note the port information here shall be identical with the port value you set in TCP port in Web Network interface. Otherwise, you cannot login the device.

If you are using device background upgrade port 3800 to login, other setups are all invalid.



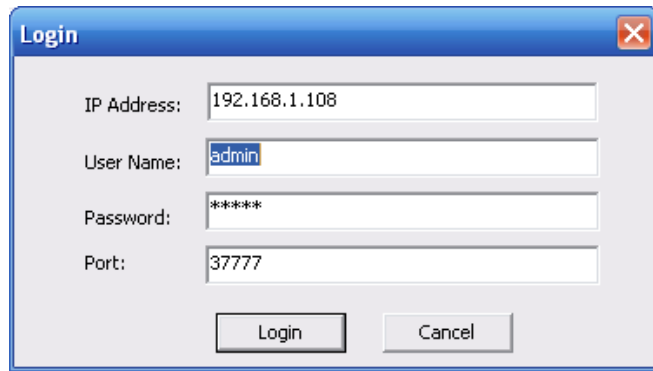

Figure 6- 4

After you logged in, the configuration tool main interface is shown as below. See Figure 6- 5.

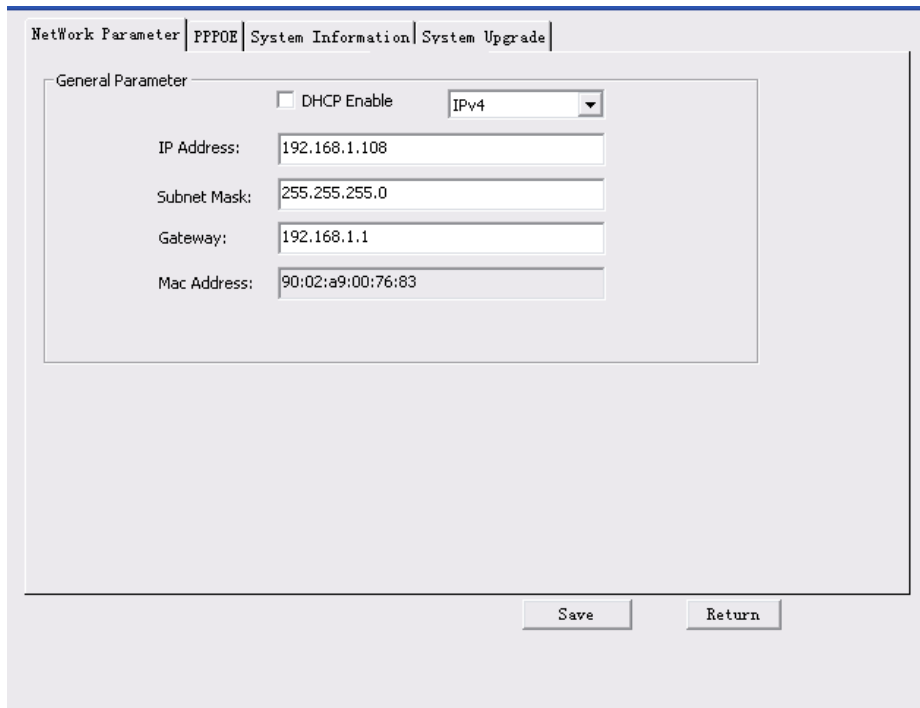

Figure 6- 5

**For detailed information and operation instruction of the quick configuration tool, please refer to the *Quick Configuration Tool User's Manual* included in the resources CD.**

## 7 Technical Specification

Parameter Type	Parameter Name	Value
	Model	ITC237-PW1A-IRZ
Camera	Sensor	1/1.9 inch CMOS
	Shutter	1/12.5~1/10000, manual or auto
	Min Illumination	0.002Lux/F1.2 (color mode) ,0.0002Lux/F1.2 (black white mode)
	Scan	Progressive
	Day/Night Mode Switch	IR-CUT motorized cut
	Exposure Mode	Support full auto, customized range auto and customized
	White Balance	Support full auto, HUE range auto, and customized HUE
	HLC	Support
	Edge Enhance	Support
Lens	Lens Port	φ14
	Lens Focus	4mm~8mm
	Lens Iris	F1.8
	Iris Control	DC drive
	Focal Type	Motorized
Image	Image Compression Standard	JPEG
	Image Resolution	1920x1080
	Video Compression Standard	H.264/H.264H/
	Bit Stream	H.264 stream adjustable
	Video Frame Rate	50s
	Video Resolution	1920x1080
Trigger Mode	I/O Coil Trigger	Support
	Video Detection	Support
Function	White-list	Max support 10000 vehicles on white-list, may directly link gateway to output
	Intelligent Recognition	Plate recognition, vehicle color recognition, LOGO recognition
	Remote Control	Remote config, control via Web
	OSD Info Overlay	Support, may define time, location, direction, lane no. And etc.
	Water-proof	Support, video/picture with water-proof function
Port	Built-in IR	Built-in 2 LED IR lights
	Network Port	1, 100/1000M Ethernet port
	Alarm Input Port	2-ch, opt coupler input (switch), may used in coil input
	Alarm Output	1-ch, relay output, may used to link gateway
	Audio Port	N/A
General	Power	AC 24V

Parameter Type	Parameter Name	Value
	Power Sync	Support
	Consumption	<15W
	Temperature	- 30°C ~ + 60°C
	Protection Level	IP66
	Humidity	≤95%
	Dimension (mm)	94.92mmX94.92mmX272.90mm
	Weight	1.4kg

## 8 FAQ

Bug	
I cannot boot up the device.	Please click RESET button for at least five seconds to restore factory default setup.
I cannot upgrade the device via network.	The status indication light is shown as red when network upgrade operation failed. You can use port 3800 to continue upgrade.
Web control webrec.cab not pop up	Please set IE security level to low and enable ActiveX plug-in.

### Note:

- This manual is for reference only. Slight difference may be found in the user interface.
- All the designs and software here are subject to change without prior written notice.
- All trademarks and registered trademarks mentioned are the properties of their respective owners.
- If there is any uncertainty or controversy, please refer to the final explanation of us.
- Please visit our website or contact your local retailer for more information.